



DCG 700-P

English

1 Information about the documentation

1.1 About this documentation

- Read this documentation before initial operation or use. This is a prerequisite for safe, trouble-free handling and use of the product.
- Observe the safety instructions and warnings in this documentation and on the product.
- Always keep the operating instructions with the product and make sure that the operating instructions are with the product when it is given to other persons.

1.2 Explanation of symbols used

1.2.1 Warnings

Warnings alert persons to hazards that occur when handling or using the product. The following signal words are used:

DANGER

DANGER !

- ▶ Draws attention to imminent danger that will lead to serious personal injury or fatality.

WARNING

WARNING !

- ▶ Draws attention to a potential threat of danger that can lead to serious injury or fatality.





CAUTION

CAUTION !

- ▶ Draws attention to a potentially dangerous situation that could lead to slight personal injury or damage to the equipment or other property.





1.2.2 Symbols in the documentation

The following symbols are used in this document:

	Read the operating instructions before use.
	Instructions for use and other useful information
	Dealing with recyclable materials
	Do not dispose of electric equipment and batteries as household waste

1.2.3 Symbols in the illustrations

The following symbols are used in illustrations:

	These numbers refer to the corresponding illustrations found at the beginning of these operating instructions
3	The numbering reflects the sequence of operations shown in the illustrations and may deviate from the steps described in the text
	Item reference numbers are used in the overview illustrations and refer to the numbers used in the product overview section
	This symbol is intended to draw special attention to certain points when handling the product.
	Wireless data transfer

1.3 Product-dependent symbols

1.3.1 Symbols on the product

The following symbols are used on the product:

	Wear eye protection
RPM	Revolutions per minute
/min	Revolutions per minute
n	Rated speed
∅	Diameter
	Protection class II (double-insulated)

1.4 Product information

Hilti products are designed for professional use and may be operated, serviced and maintained only by trained, authorized personnel. This personnel must be informed of any particular hazards that may be encountered. The product described and its ancillary equipment may present hazards when used incorrectly by untrained personnel or when used not as directed.

- ▶ Make a note of the designation and serial number printed on the identification plate in the following table.
- ▶ Always quote this information when you contact a Hilti representative or Hilti Service to enquire about the product.

Product information

Angle grinder	DCG 700-P
Generation	01
Serial no.	

1.5 Declaration of conformity

We declare, on our sole responsibility, that the product described here complies with the applicable directives and standards. A copy of the declaration issued by the certification department can be found at the end of this documentation.

The technical documentation is filed and stored here:

Hilti Entwicklungsgesellschaft mbH | Tool Certification | Hiltistrasse 6 | 86916 Kaufering, Germany

2 Safety

2.1 General power tool safety warnings

WARNING

Read all safety warnings and all instructions. Failure to follow the warnings and instructions may result in electric shock, fire and/or serious injury.

Save all warnings and instructions for future reference.

Work area safety

- ▶ **Keep work area clean and well lit.** Cluttered or dark areas invite accidents.
- ▶ **Do not operate power tools in explosive atmospheres, such as in the presence of flammable liquids, gases or dust.** Power tools create sparks which may ignite the dust or fumes.
- ▶ **Keep children and bystanders away while operating a power tool.** Distractions can cause you to lose control.

Electrical safety

- ▶ **Power tool plugs must match the outlet. Never modify the plug in any way. Do not use any adapter plugs with earthed (grounded) power tools.** Unmodified plugs and matching outlets will reduce risk of electric shock.
- ▶ **Avoid body contact with earthed or grounded surfaces, such as pipes, radiators, ranges and refrigerators.** There is an increased risk of electric shock if your body is earthed or grounded.

- ▶ **Do not expose power tools to rain or wet conditions.** Water entering a power tool will increase the risk of electric shock.
- ▶ **Do not abuse the cord. Never use the cord for carrying, pulling or unplugging the power tool. Keep cord away from heat, oil, sharp edges or moving parts.** Damaged or entangled cords increase the risk of electric shock.
- ▶ **When operating a power tool outdoors, use an extension cord suitable for outdoor use.** Use of a cord suitable for outdoor use reduces the risk of electric shock.
- ▶ **If operating a power tool in a damp location is unavoidable, use a residual current device (RCD) protected supply.** Use of an RCD reduces the risk of electric shock.

Personal safety

- ▶ **Stay alert, watch what you are doing and use common sense when operating a power tool. Do not use a power tool while you are tired or under the influence of drugs, alcohol or medication.** A moment of inattention while operating power tools may result in serious personal injury.
- ▶ **Use personal protective equipment. Always wear eye protection.** Protective equipment such as dust mask, non-skid safety shoes, hard hat, or hearing protection used for appropriate conditions will reduce personal injuries.
- ▶ **Prevent unintentional starting. Ensure the switch is in the off-position before connecting to power source, picking up or carrying the tool.** Carrying power tools with your finger on the switch or energising power tools that have the switch on invites accidents.
- ▶ **Remove any adjusting key or wrench before turning the power tool on.** A wrench or a key left attached to a rotating part of the power tool may result in personal injury.
- ▶ **Do not overreach. Keep proper footing and balance at all times.** This enables better control of the power tool in unexpected situations.
- ▶ **Dress properly. Do not wear loose clothing or jewellery. Keep your hair, clothing and gloves away from moving parts.** Loose clothes, jewellery or long hair can be caught in moving parts.
- ▶ **If devices are provided for the connection of dust extraction and collection facilities, ensure these are connected and properly used.** Use of dust collection can reduce dust-related hazards.

Power tool use and care

- ▶ **Do not force the power tool. Use the correct power tool for your application.** The correct power tool will do the job better and safer at the rate for which it was designed.
- ▶ **Do not use the power tool if the switch does not turn it on and off.** Any power tool that cannot be controlled with the switch is dangerous and must be repaired.
- ▶ **Disconnect the plug from the power source from the power tool before making any adjustments, changing accessories, or storing power tools.** Such preventive safety measures reduce the risk of starting the power tool accidentally.
- ▶ **Store idle power tools out of the reach of children and do not allow persons unfamiliar with the power tool or these instructions to operate the power tool.** Power tools are dangerous in the hands of untrained users.
- ▶ **Maintain power tools. Check for misalignment or binding of moving parts, breakage of parts and any other condition that may affect the power tool's operation. If damaged, have the power tool repaired before use.** Many accidents are caused by poorly maintained power tools.
- ▶ **Keep cutting tools sharp and clean.** Properly maintained cutting tools with sharp cutting edges are less likely to bind and are easier to control.
- ▶ **Use the power tool, accessories and tool bits etc. in accordance with these instructions, taking into account the working conditions and the work to be performed.** Use of the power tool for operations different from those intended could result in a hazardous situation.

Service

- ▶ **Have your power tool serviced by a qualified repair person using only identical replacement parts.** This will ensure that the safety of the power tool is maintained.

2.2 Safety warnings common for grinding, sanding, wire brushing, polishing or abrasive cutting-off operations:

- ▶ **This power tool is intended to function as a grinder or cut-off tool. Read all safety warnings, instructions, illustrations and specifications provided with this power tool.** Failure to follow all instructions listed below may result in electric shock, fire and/or serious injury.
- ▶ **Operations such as sanding, wire brushing or polishing are not recommended to be performed with this power tool.** Operations for which the power tool was not designed may create a hazard and cause personal injury.

- ▶ **Do not use accessories which are not specifically designed and recommended by the tool manufacturer.** Just because the accessory can be attached to your power tool, it does not assure safe operation.
- ▶ **The rated speed of the accessory must be at least equal to the maximum speed marked on the power tool.** Accessories running faster than their rated speed can break and fly apart.
- ▶ **The outside diameter and the thickness of your accessory must be within the capacity rating of your power tool.** Incorrectly sized accessories cannot be adequately guarded or controlled.
- ▶ **Threaded mounting of accessories must match the grinder spindle thread. For accessories mounted by flanges, the arbour hole of the accessory must fit the locating diameter of the flange.** Accessories that do not match the mounting hardware of the power tool will run out of balance, vibrate excessively and may cause loss of control.
- ▶ **Do not use a damaged accessory. Before each use inspect the accessory such as abrasive wheels for chips and cracks, backing pad for cracks, tear or excess wear, wire brush for loose or cracked wires. If power tool or accessory is dropped, inspect for damage or install an undamaged accessory. After inspecting and installing an accessory, position yourself and bystanders away from the plane of the rotating accessory and run the power tool at maximum no-load speed for one minute.** Damaged accessories will normally break apart during this test time.
- ▶ **Wear personal protective equipment. Depending on application, use face shield, safety goggles or safety glasses. As appropriate, wear dust mask, hearing protectors, gloves and workshop apron capable of stopping small abrasive or workpiece fragments.** The eye protection must be capable of stopping flying debris generated by various operations. The dust mask or respirator must be capable of filtering particles generated by your operation. Prolonged exposure to high intensity noise may cause hearing loss.
- ▶ **Keep bystanders a safe distance away from work area. Anyone entering the work area must wear personal protective equipment.** Fragments of workpiece or of a broken accessory may fly away and cause injury beyond immediate area of operation.
- ▶ **Hold the power tool by insulated gripping surfaces only, when performing an operation where the cutting accessory may contact hidden wiring or its own cord.** Cutting accessory contacting a "live" wire may make exposed metal parts of the power tool "live" and could give the operator an electric shock.
- ▶ **Position the cord clear of the spinning accessory.** If you lose control, the cord may be cut or snagged and your hand or arm may be pulled into the spinning accessory.
- ▶ **Never lay the power tool down until the accessory has come to a complete stop.** The spinning accessory may grab the surface and pull the power tool out of your control.
- ▶ **Do not run the power tool while carrying it at your side.** Accidental contact with the spinning accessory could snag your clothing, pulling the accessory into your body.
- ▶ **Regularly clean the power tool's air vents.** The motor's fan will draw the dust inside the housing and excessive accumulation of powdered metal may cause electrical hazards.
- ▶ **Do not operate the power tool near flammable materials.** Sparks could ignite these materials.
- ▶ **Do not use accessories that require liquid coolants.** Using water or other liquid coolants may result in electrocution or shock.

Kickback and related warnings

Kickback is a sudden reaction to a pinched or snagged rotating wheel, backing pad, brush or any other accessory. Pinching or snagging causes rapid stalling of the rotating accessory which in turn causes the uncontrolled power tool to be forced in the direction opposite of the accessory's rotation at the point of the binding.

For example, if an abrasive wheel is snagged or pinched by the workpiece, the edge of the wheel that is entering into the pinch point can dig into the surface of the material causing the wheel to climb out or kick out. The wheel may either jump toward or away from the operator, depending on direction of the wheel's movement at the point of pinching. Abrasive wheels may also break under these conditions.

Kickback is the result of power tool misuse and/or incorrect operating procedures or conditions and can be avoided by taking proper precautions as given below.

- ▶ **Maintain a firm grip on the power tool and position your body and arm to allow you to resist kickback forces. Always use auxiliary handle, if provided, for maximum control over kickback or torque reaction during start-up.** The operator can control torque reactions or kickback forces, if proper precautions are taken.
- ▶ **Never place your hand near the rotating accessory.** Accessory may kickback over your hand.
- ▶ **Do not position your body in the area where power tool will move if kickback occurs.** Kickback will propel the tool in direction opposite to the wheel's movement at the point of snagging.

- ▶ **Use special care when working corners, sharp edges etc. Avoid bouncing and snagging the accessory.** Corners, sharp edges or bouncing have a tendency to snag the rotating accessory and cause loss of control or kickback.
- ▶ **Do not attach a saw chain woodcarving blade or toothed saw blade.** Such blades create frequent kickback and loss of control.

Safety warnings specific for grinding and abrasive cutting-off operations:

- ▶ **Use only wheel types that are recommended for your power tool and the specific guard designed for the selected wheel.** Wheels for which the power tool was not designed cannot be adequately guarded and are unsafe.
- ▶ **The grinding surface of centre depressed wheels must be mounted below the plane of the guard lip.** An improperly mounted wheel that projects through the plane of the guard lip cannot be adequately protected.
- ▶ **The guard must be securely attached to the power tool and positioned for maximum safety, so the least amount of wheel is exposed towards the operator.** The guard helps to protect the operator from broken wheel fragments, accidental contact with wheel and sparks that could ignite clothing.
- ▶ **Wheels must be used only for recommended applications. For example: do not grind with the side of cut-off wheel.** Abrasive cut-off wheels are intended for peripheral grinding, side forces applied to these wheels may cause them to shatter.
- ▶ **Always use undamaged wheel flanges that are of correct size and shape for your selected wheel.** Proper wheel flanges support the wheel thus reducing the possibility of wheel breakage. Flanges for cut-off wheels may be different from grinding wheel flanges.
- ▶ **Do not use worn down wheels from larger power tools.** Wheel intended for larger power tool is not suitable for the higher speed of a smaller tool and may burst.

Additional safety warnings specific for abrasive cutting-off operations:

- ▶ **Do not "jam" the cut-off wheel or apply excessive pressure. Do not attempt to make an excessive depth of cut.** Overstressing the wheel increases the loading and susceptibility to twisting or binding of the wheel in the cut and the possibility of kickback or wheel breakage.
- ▶ **Do not position your body in line with and behind the rotating wheel.** When the wheel, at the point of operation, is moving away from your body, the possible kickback may propel the spinning wheel and the power tool directly at you.
- ▶ **When wheel is binding or when interrupting a cut for any reason, switch off the power tool and hold the power tool motionless until the wheel comes to a complete stop. Never attempt to remove the cut-off wheel from the cut while the wheel is in motion otherwise kickback may occur.** Investigate and take corrective action to eliminate the cause of wheel binding.
- ▶ **Do not restart the cutting operation in the workpiece. Let the wheel reach full speed and carefully re-enter the cut.** The wheel may bind, walk up or kickback if the power tool is restarted in the workpiece.
- ▶ **Support panels or any oversized workpiece to minimize the risk of wheel pinching and kickback.** Large workpieces tend to sag under their own weight. Supports must be placed under the workpiece near the line of cut and near the edge of the workpiece on both sides of the wheel.
- ▶ **Use extra caution when making a "pocket cut" into existing walls or other blind areas.** The protruding wheel may cut gas or water pipes, electrical wiring or objects that can cause kickback.

2.3 Additional safety instructions

Personal safety

- ▶ Use the tool only when it is in technically faultless condition.
- ▶ Never tamper with or modify the tool in any way.
- ▶ Always hold the power tool with both hands on the grips provided. Keep the grips clean and dry.
- ▶ Avoid touching rotating parts – risk of injury!
- ▶ Wear ANSI Z87.1 approved protective glasses, a hard hat, ear protection, protective gloves and light respiratory protection while using the power tool.
- ▶ Take breaks between working and do physical exercises to improve the blood circulation in your fingers. Exposure to vibration during long periods of work can lead to disorders of the blood vessels and nervous system in the fingers, hands and wrists.
- ▶ The power tool is not intended for use by debilitated persons who have received no special training. Keep the power tool out of reach of children.
- ▶ Do not use the power tool if it starts suddenly or with a jolt. This may indicate a fault in the electronics. Have the power tool repaired by Hilti Service right away.
- ▶ Apply appropriate safety measures at the opposite side of the workpiece in work that involves breaking through. Pieces of debris could drop out and / or fall down and injure other persons.

- ▶ Slits cut in load-bearing walls of buildings or other structures may influence the statics of the structure, especially when steel reinforcing bars or load-bearing components are cut through. Consult the responsible structural engineer, architect or person in charge of the building project before beginning the work.
- ▶ Before beginning the work, check the hazard classification of the dust that will be produced. Use an industrial vacuum cleaner with an officially approved protection classification in compliance with locally applicable dust protection regulations.
- ▶ Use a dust removal system and suitable vacuum cleaner whenever possible. Dust from materials, such as paint containing lead, some wood species, concrete/masonry/stone containing silica, and minerals as well as metal, may be harmful.
- ▶ Make sure that the workplace is well ventilated and, where necessary, wear a respirator appropriate for the type of dust generated. Contact with or inhalation of the dust may cause allergic reactions and/or respiratory or other diseases to the operator or bystanders. Certain kinds of dust are classified as carcinogenic such as oak and beech dust, especially in conjunction with additives for wood conditioning (chromate, wood preservative). Material containing asbestos may be handled only by specialists.
- ▶ To reduce the risk of injury, use only genuine **Hilti** accessories and accessory tools.
- ▶ Observe the national health and safety requirements.

Electrical safety

- ▶ Before beginning work, check the working area for concealed electric cables or gas and water pipes. External metal parts of the power tool may give you an electric shock if you damage an electric cable accidentally.
- ▶ Do not touch the supply cord or extension cord if damaged while working. Disconnect the supply cord plug from the power outlet. Check the tool's supply cord at regular intervals and have it replaced by **Hilti** Service if damage is found. Check extension cords at regular intervals and replace them if found to be damaged.
- ▶ Dirty or dusty power tools that have been used frequently for work on conductive materials should be checked at regular intervals at a **Hilti** Service Center. Dust (especially dust from conductive materials) or dampness adhering to the surface of the tool may, under unfavorable conditions, lead to electric shock.

Using and handling power tools with care

- ▶ Secure the workpiece. A workpiece clamped in a vice or secured by some other clamping device is more secure than when held only by hand.
- ▶ Wait until the power tool stops completely before you lay it down.
- ▶ Grinding discs must be stored and handled carefully in accordance with the manufacturer's instructions.
- ▶ Have the tool checked by **Hilti** Service after breakage of a disc, if the tool has been dropped or has fallen, or in the event of other mechanical damage.

3 Description

3.1 Overview of the product

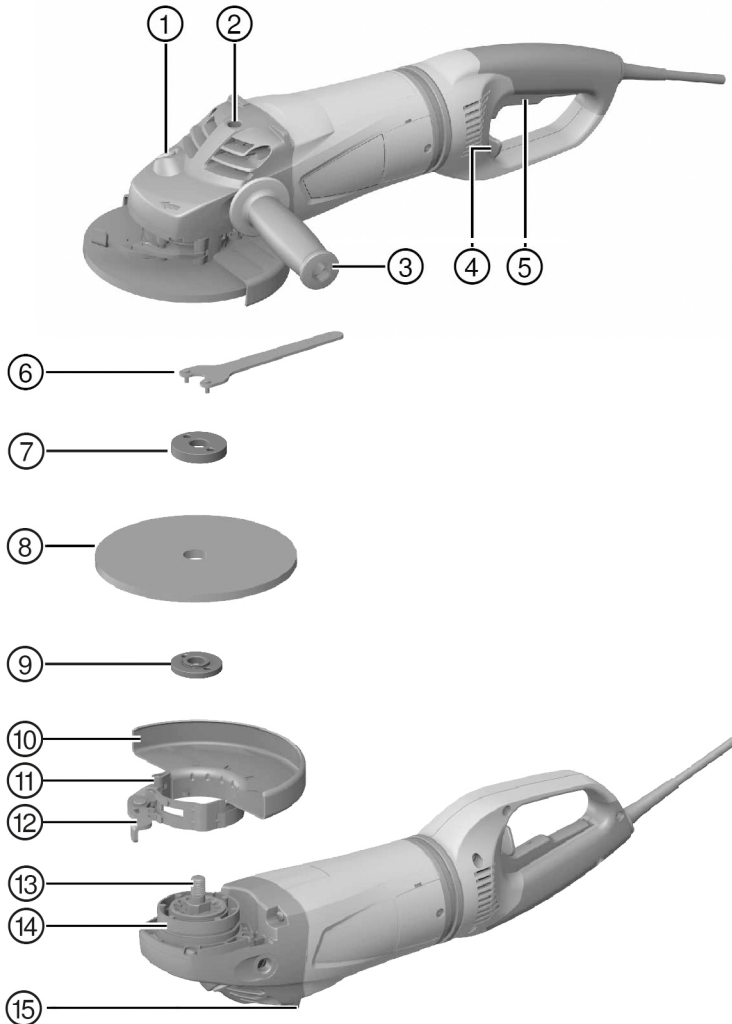

- ① Spindle lockbutton
- ② Threaded bushing for the side handle
- ③ Side handle
- ④ Release lever for pivot able side handle
- ⑤ On/off switch
- ⑥ Wrench
- ⑦ Clamping nut
- ⑧ Abrasive cutting disc / abrasive grinding disc

- ⑨ Clamping flange
- ⑩ Hood
- ⑪ Adjusting screw
- ⑫ Clamping lever
- ⑬ Spindle
- ⑭ Keyed locating lug
- ⑮ Steadying rib

3.2 Intended use

The product described is a hand-held electric angle grinder. It is designed for cutting and grinding metal and mineral materials without use of water. It may used only for dry cutting / grinding.

The tool may be operated only when connected to a power supply providing a voltage and frequency in compliance with the information given on its type plate.

3.3 Items supplied

Angle grinder, guard, side handle, clamping flange, clamping nut, wrench and operating instructions.

Other system products approved for use with this product can be found at your local **Hilti Store** or at: **www.hilti.group** | USA: **www.hilti.com**

3.4 Starting current limitation

The electronic starting current limiter reduces the starting current drawn by the power tool and thus prevents the mains fuse blowing. It also allows the angle grinder to start smoothly, without a jolt.

3.5 Active Torque Control (ATC)

The electronics detect potential stalling of the disc and prevent further rotation of the drive spindle by switching off the tool.

If the ACT system has been triggered, restart the tool. Do this by releasing the on/off switch and then pressing it again.

i If the ATC system malfunctions, the electric tool will run only at greatly reduced speed and with greatly reduced torque. Have the tool checked by **Hilti Service**.

3.6 Restart interlock

The angle grinder does not restart by itself when the on/off switch is in the pressed position and the power returns after an interruption in the electric supply. The on/off switch must first be released and then pressed again to restart.

3.7 Guard with cover plate (accessory)



When grinding with straight grinding discs and cutting with cutting discs in metalworking applications, use the guard with cover plate.

4 Consumables

Only synthetic resin-bonded, fiber-reinforced discs with a maximum \varnothing of 7" which are approved for use at a rotational speed of at least 8500/min and a peripheral speed of 80 m/s may be used.

The maximum grinding disc thickness is 1/4" and the maximum cutting disc thickness is 1/8".

WARNING! When cutting or slitting with cutting discs, always use the guard with cover plate.

Discs

	Application	Designation	Material
Abrasive cutting disc	Cutting, slitting	AC-D	Metal
Diamond cutting disc	Cutting, slitting	DC-D	Mineral
Abrasive grinding disc	Rough grinding	AG-D, AF-D, AN-D	Metal
Diamond grinding disc	Rough grinding	DG-CW	Mineral

Suitability of discs for the equipment used

Equipment	AC-D	AG-D	AF-D	AN-D	DG-CW	DC-D
Guard	—	X	X	X	X	—
Guard with cover plate	X	—	—	—	—	X
Side handle	X	X	X	X	X	X
Clamping nut (not for use with accessories with integrated thread)	X	X	X	X	X	X
Clamping flange (not for use with accessories with integrated thread)	X	X	X	X	X	X

5 Technical data

When powered by a generator or transformer, the generator or transformer's power output must be at least twice the rated input power shown on the rating plate of the power tool. The operating voltage of the transformer or generator must always be within +5% and -15% of the rated voltage of the power tool.

The information given applies to a rated voltage of 120 V. The data may vary in the event of deviations from the rated voltage and for country-specific versions. Please refer to the power tool's rating plate for details of its voltage, frequency, current and input power ratings.

	DCG 700-P
Rated current input	15 A
Rated frequency	60 Hz
Rated speed	8,500 /min
Maximum disc diameter	7 in
Weight	13.0 lb (5.9 kg)
Drive spindle thread	5/8"-11
Thread length	3/4"

6 Preparations at the workplace

CAUTION

Risk of injury! Inadvertent starting of the product.

- ▶ Unplug the supply cord before making adjustments to the power tool or before changing accessories.

Observe the safety instructions and warnings in this documentation and on the product.

6.1 Fitting the guard or guard with cover plate



The keying on the guard ensures that only a guard designed for use with the power tool can be fitted. The keyed locating lug also prevents the guard from coming into contact with the disc.

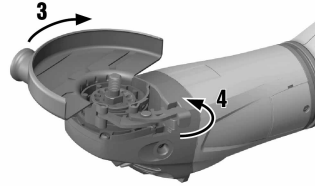
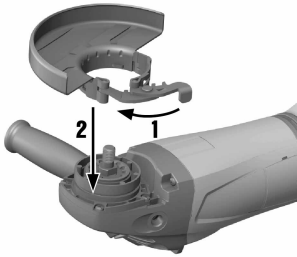

1. Release the clamping lever.
2. Fit the guard onto the spindle collar so that the keyed locating lug engages in the recess provided.
3. Rotate the guard to the required position.
4. Secure the guard by closing the clamping lever.



The guard is already set to the correct tension by way of the adjusting screw. If the tension is too low when the guard is fitted, the adjusting screw can be tightened slightly to increase the tension.

6.2 Adjusting the guard or guard with cover plate

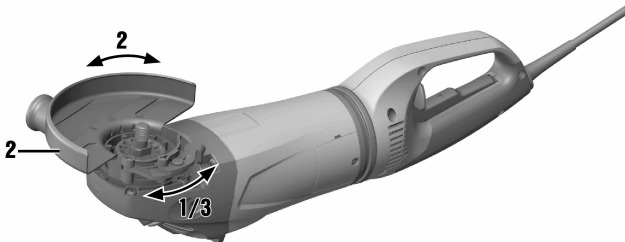

1. Release the clamping lever.
2. Rotate the guard to the required position.
3. Secure the guard by closing the clamping lever.

6.3 Removing the guard or guard with cover plate

1. Release the clamping lever.
2. Rotate the guard until the keyed locating lug is aligned with the keyed locating groove and then remove the guard.

6.4 Fitting the side handle

- ▶ Screw the side handle into one of the threaded bushings provided.

6.5 Fitting and removing accessory tools



CAUTION

Risk of injury. The accessory tool may be hot.

- ▶ Wear protective gloves when changing the accessory tool.

- i** Diamond discs must be replaced when their cutting or grinding performance drops significantly. This generally is the case when the diamond segments reach a height of less than 2 mm (1/16"). Other discs must be replaced when their cutting performance drops significantly or other parts of the angle grinder (not the disc) come into contact with the material you are working on. Abrasive discs must be replaced when their expiry date has been reached.

6.6 Fitting an accessory tool

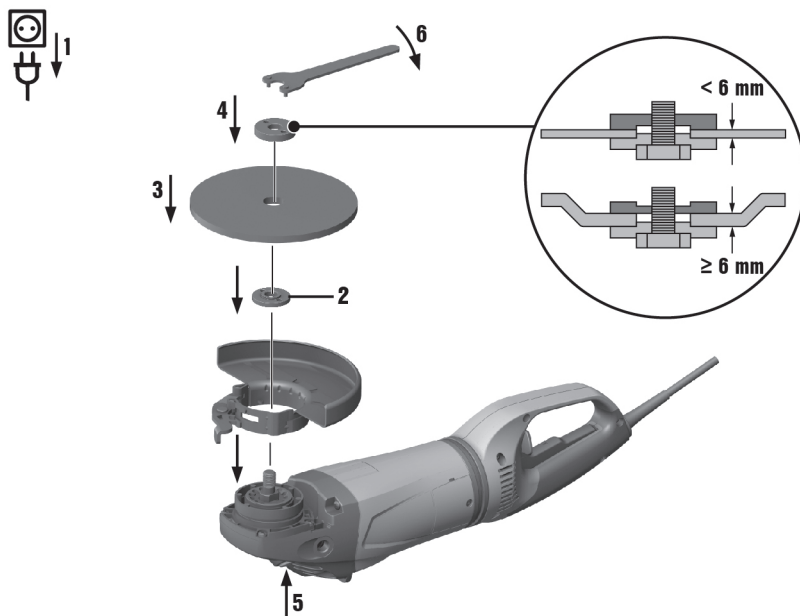

1. Disconnect the mains plug from the power outlet.
2. Clean the clamping flange and the clamping nut.
3. Fit the clamping flange onto the drive spindle.
4. Fit the accessory tool.
5. Screw on the clamping nut corresponding to the type of accessory tool fitted.
6. Press the spindle lockbutton and hold it in this position.
7. Use the pin wrench to tighten the clamping nut securely, then release the spindle lockbutton and remove the wrench.

6.7 Removing the accessory tool

1. Disconnect the supply cord plug from the power outlet.

CAUTION

Risk of breakage and irreparable damage. If the spindle lockbutton is pressed while the spindle is rotating, this may cause the accessory tool to work loose or detach from the power tool.

- ▶ Press the spindle lockbutton only when the spindle has stopped rotating.
2. Press the spindle lockbutton and hold it in this position.
 3. Release the clamping nut by gripping it with the pin wrench and turning the nut counterclockwise.
 4. Release the spindle lockbutton and remove the accessory tool.

6.8 Adjusting the side handle

⚠ WARNING

Risk of injury. If the grip position is adjusted while the tool is in operation it is no longer possible to hold the tool in a stable position, resulting in a risk of accident.

- ▶ Do not, under any circumstances, attempt to adjust the grip while the tool is running.
- ▶ Check to ensure that the grip is engaged in one of the three possible positions.

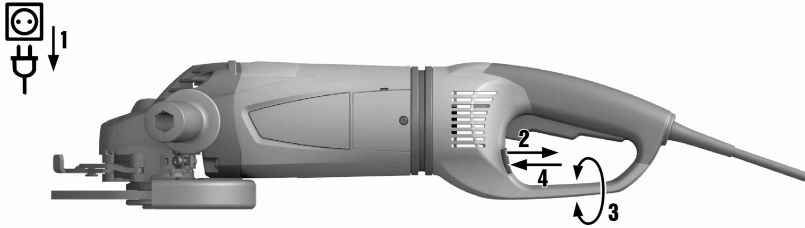

1. Disconnect the supply cord plug from the power outlet.
2. Release the locking lever by pulling it back.
3. Pivot the grip to the left or right as far as it will go.
4. Secure the grip in position by closing the locking lever.



The angle grinder cannot be switched on so long as the side handle is not locked in one of the three possible positions.

7 Types of work

⚠ WARNING

A damaged supply cord presents a hazard! Do not touch the supply cord or extension cord if damaged while working. Disconnect the supply cord plug from the power outlet.

- ▶ Check the appliance's supply cord at regular intervals and have it replaced by a qualified specialist if found to be damaged.

Check extension cords at regular intervals and replace them if found to be damaged.

7.1 Grinding

⚠ CAUTION

Risk of injury. The accessory tool may suddenly stick or stall.

- ▶ Use the power tool with the side handle fitted and always hold it securely with both hands.

7.1.1 Rough grinding

⚠ CAUTION

Risk of injury. The abrasive cutting disc could shatter and flying fragments may cause injury.

- ▶ Never use abrasive cutting discs for grinding.
- ▶ Move the power tool to and fro while maintaining a 5° to 30° angle of attack and applying moderate pressure.
 - ◀ This will avoid overheating and discoloration of the workpiece and help ensure an even surface finish.

7.1.2 Cutting

- ▶ When cutting, apply moderate feed pressure and do not tilt the power tool or, respectively, the cutting disc (hold at approx. 90° to the surface being cut).



For best results when cutting profiles and square tube, start cutting at the smallest cross section.

7.2 Switching on (switch with lock)

1. Plug the supply cord into the power outlet.
2. Push the on/off switch forward (3 mm).
3. Press the on/off switch and push it forward it as far as it will go into the pressed position until it engages.
 - ◀ The motor runs.

7.3 Switching off (switch with lock)

- ▶ Press the front part of the on/off switch down
 - ◀ The on/off switch jumps into the off position and the motor stops.

8 Care and maintenance



WARNING

Danger of electric shock! Carrying out care and maintenance while the supply cord is connected to the power outlet presents a risk of serious injuries including burns.

- ▶ Always unplug the supply cord before carrying out all care and maintenance tasks.

Care

- ▶ Remove stubborn dirt.
- ▶ Clean the air vents carefully using a dry brush.
- ▶ Clean the housing at regular intervals, using a slightly damp cloth.
 - ◀ Do not use cleaning agents containing silicone as these can attack the plastic parts.

Maintenance

- ▶ Check all visible parts and controls for signs of damage at regular intervals and make sure that they all function correctly.
 - ◀ Do not continue to operate the power tool if signs of damage are found or if parts malfunction.
- ▶ Use only genuine accessories for repairs.
- ▶ After carrying out care and maintenance, check that all protective and safety devices are fitted and that they function faultlessly.

9 Transport and storage

- Do not transport electric tools with accessory tools fitted.
- Always unplug the supply cord before storing an electric tool or appliance.
- Store tools and appliances in a dry place where they cannot be accessed by children or unauthorized persons.
- Check electric tools or appliances for damage after long periods of transport or storage.

10 Troubleshooting

If the trouble you are experiencing isn't listed in this table or you are unable to remedy the problem by yourself, please contact **Hilti Service**.

Trouble or fault	Possible cause	Action to be taken
The power tool doesn't start.	Interruption in the electric supply.	▶ Plug in another electric tool or appliance and check whether it works.

Trouble or fault	Possible cause	Action to be taken
The power tool doesn't start.	The supply cord or plug is defective.	▶ Have the supply cord and plug checked by a trained electrical specialist and replaced if necessary.
	The carbon brushes are worn.	▶ Have the power tool checked by a trained electrical specialist and the carbon brushes replaced if necessary.
	The restart interlock is active after disconnection or an interruption in the electric supply.	▶ First release the on/off switch lockbutton and then switch on again.
The tool does not achieve full power.	The extension cord conductor cross section (gauge) is inadequate.	▶ Use an extension cord with an adequate conductor cross section.
	Malfunction in the ATC system.	▶ Have the product repaired by Hilti Service .

11 Disposal

Most of the materials from which **Hilti** tools and appliances are manufactured can be recycled. The materials must be correctly separated before they can be recycled. In many countries, your old tools, machines or appliances can be returned to **Hilti** for recycling. Ask **Hilti Service** or your Hilti representative for further information.



- ▶ Disposal of electric tools or appliances together with household waste is not permissible.

12 Manufacturer's warranty

- ▶ Please contact your local **Hilti** representative if you have questions about the warranty conditions.

This Product is Certified
Ce produit est homologué
Producto homologado por
Este producto está registrado





Hilti Corporation
LI-9494 Schaan
Tel.: +423 234 21 11
Fax: +423 234 29 65
www.hilti.com