

# HILTI

**BX 3-ME**

**BX 3-IF**

English







## 1 Information about the documentation

### 1.1 Explanation of signs used



#### 1.1.1 Warnings

Warnings alert persons to hazards that occur when handling or using the product. The following signal words are used in combination with an icon:

	<b>DANGER!</b> Draws attention to imminent danger that will lead to serious personal injury or fatality.
	<b>WARNING!</b> Draws attention to a potentially dangerous situation that could lead to serious personal injury or fatality.
	<b>CAUTION!</b> Draws attention to a potentially dangerous situation that could lead to minor personal injury or damage to the equipment or other property.







#### 1.1.2 Symbols

The following symbols are used in this document:

	Read the operating instructions before use.
	General warning
	Instructions for use and other useful information



#### 1.1.3 Symbols on the product

The following symbols are used on the product:

	General mandatory sign
	Wear eye protection
	Wear ear protection
	Wear a hard hat
	Return waste material for recycling
	Direct current (DC)

#### 1.1.4 Characters used in illustrations

The illustrations in these operating instructions are intended to promote a better understanding and may deviate from the actual version of the product.

	These numbers refer to the corresponding illustrations found at the beginning of these operating instructions.
3	The numbering in the illustrations reflects the order of the work steps in the illustration and may deviate from the numbering of work steps in the text.
	Item reference numbers are used in the <b>overview illustration</b> and refer to the numbers used in the <b>product overview</b> section. In the product overview section, the numbers shown in the legend relate to these item reference numbers.
	These characters are intended to specifically draw your attention to certain points when handling the product.

### 1.2 About this documentation

- ▶ Read these operating instructions before the product is used or operated for the first time. This is a prerequisite for safe, trouble-free handling and use of the product.

- ▶ Observe the safety instructions and warnings in this documentation and on the product.
- ▶ This document forms a permanent, integral part of the product described and must always be with the product when it is handed over to other persons.

### 1.3 Product information

Hilti products are designed for professional use and may be operated, serviced and maintained only by trained, authorized personnel. This personnel must be informed of any particular hazards that may be encountered. The product and its ancillary equipment may present hazards when used incorrectly by untrained personnel or when used not as directed. The type designation and serial number are printed on the type identification plate.

- ▶ Write down the serial number in the table below. You will be required to state the product details when contacting Hilti Service or your local Hilti organization to enquire about the product.

#### Product information

Type:	BX 3-ME   BX 3-IF
Generation:	01
Serial number:	

## 2 Safety

### 2.1 Safety instructions

The safety instructions given in the following section contain all the general safety instructions for power tools which are to be listed in the operating instructions in accordance with the applicable standards. As a result, some of the instructions listed may not be relevant to this tool.

#### 2.1.1 General power tool safety warnings

##### WARNING

**Read all safety warnings and all instructions.** Failure to follow the warnings and instructions may result in electric shock, fire and/or serious injury.

**Save all warnings and instructions for future reference.**

The term “power tool” in the warnings refers to your mains-operated (corded) power tool or battery-operated (cordless) power tool.

##### Work area safety

- ▶ **Keep work area clean and well lit.** Cluttered or dark areas invite accidents.
- ▶ **Do not operate power tools in explosive atmospheres, such as in the presence of flammable liquids, gases or dust.** Power tools create sparks which may ignite the dust or fumes.
- ▶ **Keep children and bystanders away while operating a power tool.** Distractions can cause you to lose control.

##### Electrical safety

- ▶ **Power tool plugs must match the outlet. Never modify the plug in any way. Do not use any adapter plugs with earthed (grounded) power tools.** Unmodified plugs and matching outlets will reduce risk of electric shock.
- ▶ **Avoid body contact with earthed or grounded surfaces, such as pipes, radiators, ranges and refrigerators.** There is an increased risk of electric shock if your body is earthed or grounded.
- ▶ **Do not expose power tools to rain or wet conditions.** Water entering a power tool will increase the risk of electric shock.
- ▶ **Do not abuse the cord. Never use the cord for carrying, pulling or unplugging the power tool. Keep cord away from heat, oil, sharp edges or moving parts.** Damaged or entangled cords increase the risk of electric shock.
- ▶ **When operating a power tool outdoors, use an extension cord suitable for outdoor use.** Use of a cord suitable for outdoor use reduces the risk of electric shock.
- ▶ **If operating a power tool in a damp location is unavoidable, use a residual current device (RCD) protected supply.** Use of an RCD reduces the risk of electric shock.

##### Personal safety

- ▶ **Stay alert, watch what you are doing and use common sense when operating a power tool. Do not use a power tool while you are tired or under the influence of drugs, alcohol or medication.** A moment of inattention while operating power tools may result in serious personal injury.

- ▶ **Use personal protective equipment. Always wear eye protection.** Protective equipment such as dust mask, non-skid safety shoes, hard hat, or hearing protection used for appropriate conditions will reduce personal injuries.
- ▶ **Prevent unintentional starting. Ensure the switch is in the off-position before connecting to power source and/or battery pack, picking up or carrying the tool.** Carrying power tools with your finger on the switch or energising power tools that have the switch on invites accidents.
- ▶ **Remove any adjusting key or wrench before turning the power tool on.** A wrench or a key left attached to a rotating part of the power tool may result in personal injury.
- ▶ **Do not overreach. Keep proper footing and balance at all times.** This enables better control of the power tool in unexpected situations.
- ▶ **Dress properly. Do not wear loose clothing or jewellery. Keep your hair, clothing and gloves away from moving parts.** Loose clothes, jewellery or long hair can be caught in moving parts.
- ▶ **If devices are provided for the connection of dust extraction and collection facilities, ensure these are connected and properly used.** Use of dust collection can reduce dust-related hazards.

#### Power tool use and care

- ▶ Do not force the power tool. Use the correct power tool for your application. The correct power tool will do the job better and safer at the rate for which it was designed.
- ▶ **Do not use the power tool if the switch does not turn it on and off.** Any power tool that cannot be controlled with the switch is dangerous and must be repaired.
- ▶ **Disconnect the plug from the power source and/or the battery pack from the power tool before making any adjustments, changing accessories, or storing power tools.** Such preventive safety measures reduce the risk of starting the power tool accidentally.
- ▶ **Store idle power tools out of the reach of children and do not allow persons unfamiliar with the power tool or these instructions to operate the power tool.** Power tools are dangerous in the hands of untrained users.
- ▶ **Maintain power tools. Check for misalignment or binding of moving parts, breakage of parts and any other condition that may affect the power tool's operation. If damaged, have the power tool repaired before use.** Many accidents are caused by poorly maintained power tools.
- ▶ **Keep cutting tools sharp and clean.** Properly maintained cutting tools with sharp cutting edges are less likely to bind and are easier to control.
- ▶ **Use the power tool, accessories and tool bits etc. in accordance with these instructions, taking into account the working conditions and the work to be performed.** Use of the power tool for operations different from those intended could result in a hazardous situation.

#### Battery tool use and care

- ▶ **Recharge only with the charger specified by the manufacturer.** A charger that is suitable for one type of battery pack may create a risk of fire when used with another battery pack.
- ▶ **Use power tools only with specifically designated battery packs.** Use of any other battery packs may create a risk of injury and fire.
- ▶ **When battery pack is not in use, keep it away from other metal objects, like paper clips, coins, keys, nails, screws or other small metal objects, that can make a connection from one terminal to another.** Shorting the battery terminals together may cause burns or a fire.
- ▶ **Under abusive conditions, liquid may be ejected from the battery; avoid contact. If contact accidentally occurs, flush with water. If liquid contacts eyes, additionally seek medical help.** Liquid ejected from the battery may cause irritation or burns.

#### Service

- ▶ **Have your power tool serviced by a qualified repair person using only identical replacement parts.** This will ensure that the safety of the power tool is maintained.

### 2.1.2 Tacker safety warnings

- ▶ **Always assume that the tool contains fasteners.** Careless handling of the fastening tool can result in unexpected firing of nails causing personal injury.
- ▶ **Do not point the tool towards yourself or anyone nearby.** A nail will be ejected by the tool if it is triggered unexpectedly, possibly leading to injury.
- ▶ **Do not actuate the tool unless the tool is placed firmly against the workpiece.** If the tool is not in contact with the workpiece, the fastener may be deflected away from your target.
- ▶ **Disconnect the tool from the power source when the fastener jams in the tool.** While removing a jammed fastener, the fastening tool may be accidentally activated if it is plugged in.
- ▶ **Use caution while removing a jammed fastener.** The mechanism may be under tension and the nail may be forcefully ejected while attempting to free a jam.

- ▶ **When fastening electrical cables, make sure the cables are not energized. Hold the fastening tool only by insulated gripping surfaces. Use only fasteners designed for electrical cable installations. Check that the fastener has not damaged the insulation of the electrical cable.** A nail that damages the insulation of electric cables can lead to electric shock and fire hazards.

- ▶ **Do not use this fastening tool to fasten electric cables.** It is not suitable for the installation of electric cables as damage to the insulation on the electric cables may be caused, thus resulting in a risk of electric shock and fire hazards.

### 2.1.3 Additional safety instructions

#### Working safely and carefully with the fastening tools

- ▶ **Do not tamper with or modify the tool.**
- ▶ **Do not damage the casing of the tool when applying identification marks.**
- ▶ **Always remove the battery and fasteners before breaks between working, before cleaning, care or maintenance and before storage or transport.**
- ▶ **Store tools in a secure place when not in use. When not in use, tools must be stored in a dry, high place or locked away out of reach of children.**
- ▶ **Keep your arms flexed when operating the tool (do not straighten the arms).**
- ▶ **Pull the safety trigger only when the tool is pressed against the workpiece at right angles and when the edge distance and fastener spacing distance have been observed (see technical data sheet for the nail).**
- ▶ **Always hold the tool securely and at right angles to the workpiece when driving fasteners.** This will help to prevent fasteners being deflected by the workpiece.
- ▶ **Never trigger the tool again in an attempt to improve the hold of a previously driven nail or stud.** Fasteners can break or jam.
- ▶ **Do not drive fasteners into existing holes except in situations where this is recommended by Hilti.**
- ▶ **Always observe the application guidelines.**
- ▶ **Do not grip or hold the tool by the nosepiece.**
- ▶ **Do not use the magazine as a grip.**
- ▶ **Do not use the tool as a hammer.**
- ▶ **Never drop the tool.**
- ▶ **A nail will be ejected by the tool if it is triggered inadvertently, possibly leading to injury. Never press the nose of the tool against your hand or other part of your body or the body of another person. In the event of a malfunction, remove the battery, press the nose of the tool against the workpiece and pull the safety trigger.**
- ▶ **Do not cover the ventilation slots on the tool, e.g. when working using both hands, to prevent the tool from overheating.**
- ▶ **If the tool has overheated, allow it to cool down. Do not exceed the specified maximum fastener driving rate.**
- ▶ **Never use the tool if the applicable safety devices have been damaged or removed.**

#### Careful use of battery-powered tools

- ▶ **Observe the special guidelines applicable to the transport, storage and use of Li-ion batteries.**
- ▶ **Do not expose batteries to high temperatures and keep them away from fire.** There is a risk of explosion.
- ▶ **Do not disassemble, squash or incinerate batteries and do not subject them to temperatures over 80 °C (176 °F).** There is otherwise a risk of fire, explosion or chemical burns.
- ▶ **Use only batteries of the type approved for use with the applicable tool.** Use of other batteries or use of the batteries for purposes for which they are not intended presents a risk of fire and explosion.
- ▶ **Do not use the battery as a power source for other unspecified power tools.**
- ▶ **Do not apply excessive force when fitting or removing the battery.**
- ▶ **Do not attempt to continue to use or charge damaged batteries (e.g. batteries with cracks, broken parts or bent or distorted contacts).**
- ▶ **Avoid short circuiting the battery terminals. Check that the contacts on the battery and on the tool are free from foreign objects before inserting the battery into the tool.** Short circuiting the battery terminals presents a risk of fire, explosion and chemical burns.
- ▶ **Do not use the tool in wet weather (rain) or in damp conditions.**

- ▶ **Avoid ingress of moisture.** Ingress of moisture may cause a short circuit, resulting in burning injuries or fire.

### Workstation

- ▶ **Do not attempt to drive fasteners into materials that are too hard, such as welded steel or cast steel.** Attempting to drive fasteners into these materials may lead to malfunctions, incorrectly driven fasteners or breakage of fasteners.
- ▶ **Do not attempt to drive fasteners into materials that are too soft, such as wood or plasterboard.** Attempting to drive fasteners into these materials may lead to malfunctions and fasteners being driven incorrectly or driven right through the material.
- ▶ **Do not attempt to drive fasteners into materials that are too brittle, such as glass or tiles.** Attempting to drive fasteners into these materials may lead to malfunctions, fasteners being driven incorrectly and may cause the material to shatter.
- ▶ **Before driving fasteners, check that there is no risk of injuring persons or of damaging objects present behind or below the workpiece.**
- ▶ **Keep the grips dry, clean and free from oil and grease.**
- ▶ Dust from materials such as paint containing lead, some types of wood, concrete, masonry and stone containing quartz, as well as minerals and metals, may present health risks. Contact with or inhalation of the dust may cause allergic reactions and/or respiratory or other diseases among operators or bystanders. Certain kinds of dust such as oak and beech wood dust are classified as carcinogenic, especially in conjunction with additives for wood conditioning (chromate, wood preservative). Materials containing asbestos may be handled only by specialists. **Use a dust-extraction device wherever possible. When indicated, wear a respirator appropriate for the type of dust generated. Ensure that the workplace is well ventilated. Follow national requirements for the materials you want to work with.**

### Mechanical safety rules

- ▶ **Use only fasteners of a type approved for use with the tool.**

### Personal safety

- ▶ **Wear ear protectors.** Exposure to noise can cause hearing loss.
- ▶ **Improve the blood circulation in your fingers by relaxing your hands and exercising your fingers during breaks between working.**
- ▶ **The tool is not intended for use by persons who have not received special training. Keep the tool out of reach of children.**
- ▶ **Wear protective gloves to prevent the hands from chafing with frequent use of the tool.**

### Electrical safety

- ▶ Concealed electrical cables or gas and water pipes present a serious hazard if damaged while you are working. **Before beginning the work, check the working area for concealed electrical cables, gas and water pipes, e.g. using a metal detector.** External metal parts of the power tool may become live, for example, when an electrical cable is damaged accidentally.

### 3 Description

#### 3.1 Overview of the product

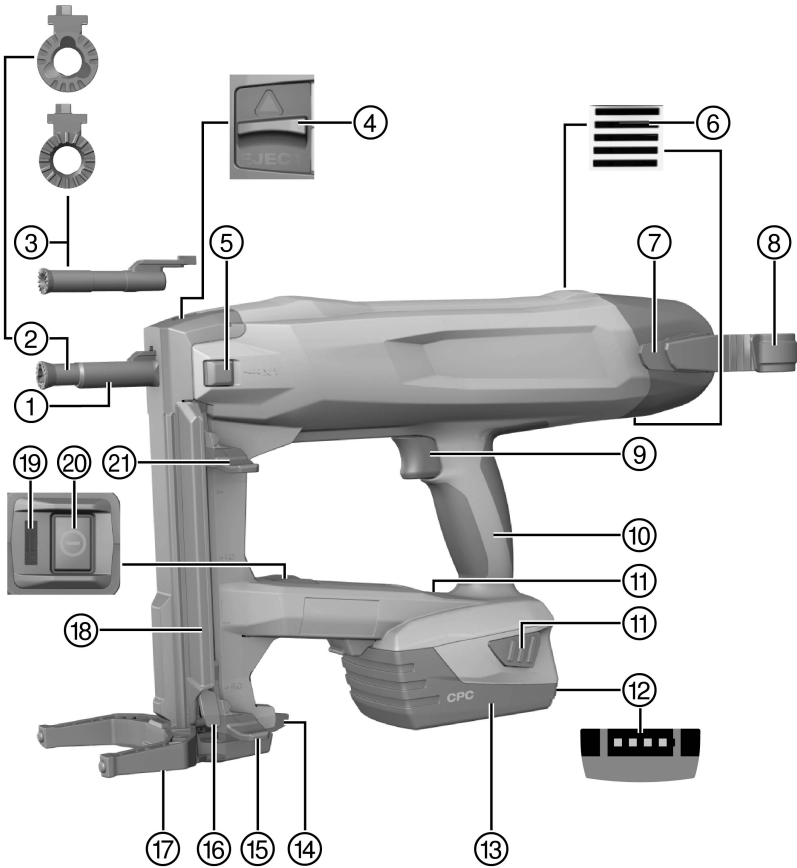



- |   |                                  |   |                                |
|---|----------------------------------|---|--------------------------------|
| ① | Nosepiece                        | ⑫ | State of charge display        |
| ② | Fastener guide X-FG B3-ME        | ⑬ | Li-ion battery                 |
| ③ | Fastener guide X-FG B3-IF        | ⑭ | Scaffold hook                  |
| ④ | Fastener guide locking mechanism | ⑮ | Nail pusher, locked position   |
| ⑤ | Single nail selector switch      | ⑯ | Nail pusher release mechanism  |
| ⑥ | Air vents                        | ⑰ | Support leg                    |
| ⑦ | Belt hook                        | ⑱ | Magazine                       |
| ⑧ | Scaffold hook                    | ⑲ | Status indicator               |
| ⑨ | Safety trigger                   | ⑳ | On/off button                  |
| ⑩ | Grip                             | ㉑ | Nail pusher, unlocked position |
| ⑪ | Release buttons                  |   |                                |

### 3.2 Intended use

The product is a hand-held, battery-operated fastening tool for indoor use. It is designed to drive specially-manufactured fasteners (nails) into concrete, steel, masonry, sand-lime block and other materials suitable for use of the direct fastening technique. The product is also designed to fasten electrical cables with clips if the appropriate fasteners are used. Use only approved fasteners in conjunction with the fastener guide designed for use with these specific fasteners (see “Technical data” section).

The fastening tool, battery and fasteners form a single technical unit. This means that trouble-free fastening can be ensured with this fastening tool only when it is used in conjunction with the **Hilti** fasteners specially designed and manufactured for it and with the batteries and chargers recommended by **Hilti**. The fastening and application recommendations made by **Hilti** apply only when this condition is observed.

- ▶ The fastening tool is for hand-held use only.
- ▶ Misuse of the fastening tool must be ruled out. Misuse of the fastening tool includes triggering in single-fastener mode without a nail inserted in the fastener guide, driving nails into very soft materials (e.g. wood), driving single nails when the tool is set up for magazine operation, and driving nails into materials that are too hard (e.g. high-strength steel or very hard natural stone).
- ▶ Use only **Hilti** Li-ion batteries of the B 18 series with this product.
- ▶ Use only **Hilti** battery chargers of the C 4/36 series to charge these batteries.

### 3.3 Safety devices

When using the nail magazine, the nail detection feature prevents triggering without a nail loaded, which could damage the fastening tool.

The contact pressure safety device is intended to prevent the free flying of nails (i.e. actuation and driving a nail when the nosepiece is not in contact with the workpiece). When using a nail magazine, the tool can be pressed against the surface and triggered only when a nail is loaded in the tool.

To use the tool in single-fastener mode, the single-fastener mode switch must be pressed before the fastening tool is pressed against the working surface.

### 3.4 Features

The fastening tool is fitted with an ergonomic, non-slip and vibration-damped grip along with a support arm with tool hook. The tool is protected from overloading by electronic overload protection and from overheating by temperature monitoring.

### 3.5 Status indicator

The status indicator provides information about the status of the fastening tool.

Status	Meaning
Off	<ul style="list-style-type: none"> <li>• The fastening tool is switched off</li> </ul>
Lights green	<ul style="list-style-type: none"> <li>• The fastening tool is switched on</li> </ul>

Further status indications are described in the troubleshooting table (see → page 15).

### 3.6 Indication of battery charge status

When one of the battery release buttons is pressed the display indicates the battery’s state of charge.

**Note**

Reliable indication of the charge status is not possible while a fastener is being driven or immediately after a fastener is driven.

Status	Meaning
All four LEDs light green.	• Charge status is 75 % to 100 %.
Three LEDs light green.	• Charge status is 50 % to 75 %.
Two LEDs light green.	• Charge status is 25 % to 50 %.
One LED lights green.	• Charge status is 10 % to 25 %.
One LED blinks green.	• Charge status is below 10 %. The tool is ready for use.

**3.7 Batteries**

Battery performance drops at low temperatures.

When battery performance drops, it takes longer until the fastening tool is ready to drive the next fastener (longer than with a fully charged battery).

If you continue to operate the fastening tool after noticing a drop in battery performance, the fastening tool will switch itself off automatically to prevent damage to the battery.

**3.8 Items supplied**

BX 3-ME or BX 3-IF fastening tool, operating instructions.

You can find other system products approved for your product at your local **Hilti** Center or online at: [www.hilti.com](http://www.hilti.com)

**4 Technical data****4.1 Fastening tool**

<b>Weight</b>	8.4 lb (3.8 kg)
<b>Nail length (collated nails)</b>	0.6 in ... 0.9 in (14 mm ... 24 mm)
<b>Nail length (single nails)</b>	1.2 in ... 1.4 in (30 mm ... 36 mm)
<b>Nail diameter</b>	0.12 in (3.0 mm)
<b>Magazine capacity</b>	20 nails
<b>Compression stroke</b>	0.5 in (12 mm)
<b>Contact pressure</b>	11 lb <sub>f</sub> ... 16 lb <sub>f</sub> (50 N ... 70 N)
<b>Recommended maximum fastening rate</b>	500/h
<b>Rated voltage</b>	21.6 V

**4.2 Examples of approved fasteners for electrical, plumbing, heating and air-conditioning systems installation applications**

In conjunction with the X-FG B3-ME fastener guide the following fasteners are approved for electrical, plumbing, heating and air-conditioning systems installation applications.

<b>Nails for magazine mode</b>	X-S 14 B3 MX   X-P 17 B3 MX   X-P 20 B3 MX   X-P 24 B3 MX
<b>Nails for single-fastening mode</b>	X-P 30 B3 P7   X-P 36 B3 P7

<b>Threaded studs for single-fastening mode</b>	X-M6-7-14 B3 P7   X-M6-7-24 B3 P7   X-W6-12-14 B3 P7   X-W6-12-20 B3 P7
<b>Fastening electric cables</b>	X-EKB MX   X-ECT MX   X-ECH MX   X-EKS MX   XEKS C MX

#### 4.3 Examples of approved fasteners for drywall applications

In conjunction with the X-FG B3-IF fastener guide the following fasteners are approved for drywall applications.

<b>Nails for magazine mode</b>	X-P 17 B3 MX   X-C 20 B3 MX   X-C 24 B3 MX
<b>Nails for single-fastening mode</b>	X-P 30 B3 P7   X-P 36 B3 P7

## 5 Preparing the tool for use

### 5.1 Charging the battery

1. Remove the battery. → page 14
2. Charge the battery in accordance with the information provided in the operating instructions for the charger.

### 5.2 Inserting the battery



#### Note

In order to achieve maximum battery lifetime, replace the discharged battery with a fully charged battery as soon as you notice a clear drop in battery performance.

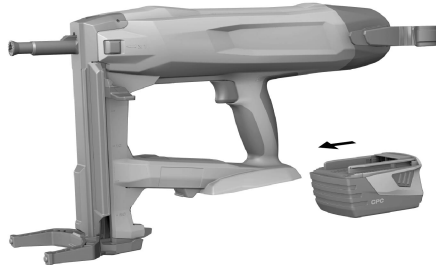

1. Check that the contacts on the battery and on the tool are free from foreign objects.
2. Fit the battery and make sure that it is heard to engage.
  - ◀ Once the battery has been fitted, the charge status LEDs light for a short time.



#### CAUTION

**A falling battery presents a hazard.** If the battery is not secured correctly it may drop out and fall while the work is in progress.

- ▶ Always check that the battery is securely seated.

3. Check that the battery is securely seated in the fastening tool.

### 5.3 Removing the fastener guide

1. Switch the fastening tool off. → page 13
2. Remove the battery. → page 14
3. Pull the nail pusher down until it engages.
4. Unload the magazine. → page 14
5. Slide the fastener guide locking catch as far as it will go in the direction of the arrow.
  - ◀ The fastener guide will be released.

- Remove the fastener guide.

#### 5.4 Inserting the fastener guide

- Switch the fastening tool off. → page 13
- Remove the battery. → page 14
- Pull the nail pusher down until it engages.
- Unload the magazine. → page 14
- Slide the fastener guide locking catch as far as it will go in the direction of the arrow and hold it in this position.
- Slide the fastener guide into the nosepiece until it is heard to engage.
- Release the fastener guide locking catch.
  - ◀ The fastener guide jumps to the middle position.
- Grip and pull the fastener guide to check that it is securely seated.

#### 5.5 Working safely with the belt and scaffold hook

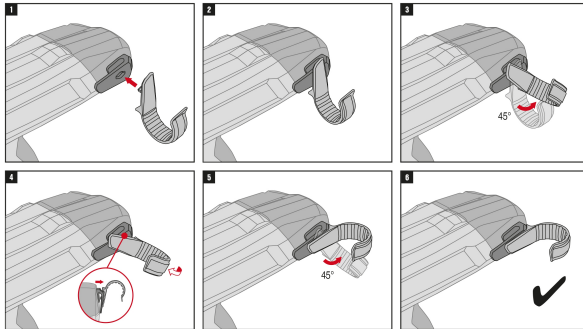

- ▶ Before beginning work, make sure that the scaffold hook is securely attached to the tool.
- ▶ Use the scaffold hook only when necessary. Lay the tool down in a safe place when it is not in use for a long period.

#### 5.6 Loading the fastening tool with nails

##### 5.6.1 Loading for magazine operation

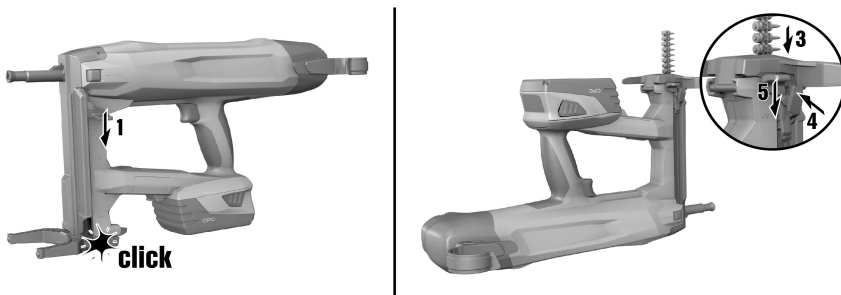

**CAUTION**  
**Risk of crushing!** The nail pusher, if it jumps back under spring pressure, may cause injury and damage to the fastening tool.

- ▶ When pulling the nail pusher down, take care to ensure that it engages securely. Do not allow the nail pusher to jump back under spring pressure.

1. Pull the nail pusher down until it engages.
2. Slide the nail strips into the magazine (a maximum of 2 strips of 10 nails).
3. Hold the nail pusher securely and press the nail pusher release button.
4. Guide the nail pusher back to its original position.

## 5.6.2 Loading in single-fastener mode

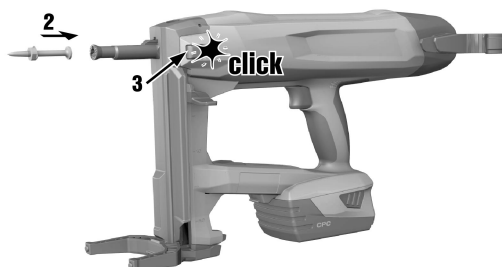

### CAUTION

**Risk of crushing!** The nail pusher, if it jumps back under spring pressure, may cause injury and damage to the fastening tool.

- ▶ When pulling the nail pusher down, take care to ensure that it engages securely. Do not allow the nail pusher to jump back under spring pressure.

1. Pull the nail pusher down until it engages.
2. Allow the nail strip to slide out of the magazine and then check that the magazine is empty.



### Note

The fastening tool may be damaged if you have not removed all the nails from the magazine before activating single-fastener mode.

3. Hold the nail pusher securely and press the nail pusher release button.
4. Guide the nail pusher back to its original position.
5. Insert the nail in the depression provided in the fastener guide. You may also then place an approved fastening element on the nose of the fastener guide.



### Note

Triggering the tool with more than one nail in the fastener guide may damage the fastening tool. When operating the tool in single-fastener mode, load only one nail into the fastener guide.

6. Activate the single-fastener selector switch.
  - ◀ The single-fastener switch should be heard to engage.



### Note

If the nail pusher is pulled down a few centimeters the single-fastener switch will disengage.

## 6 Operation

### 6.1 Using the support leg

On an even working surface, the support leg makes it easier to hold the fastening tool perpendicular as attention then only has to be paid to lateral alignment. On uneven surfaces it may be necessary to retract the support leg in order to ensure that the fastener guide is perpendicular to the working surface.

When the support leg is in the extended position it is possible to use the scaffold hook, e.g. to attach the fastening tool to a scaffold bar.

## 6.1.1 Retracting the support leg



### CAUTION

**Risk of finger injury!** When extending/retracting the support leg there is a risk of trapping the fingers between the scaffold hook and the casing of the tool.

- ▶ Hold the fastening tool by the grip when extending/retracting the support leg.

1. Push against the support leg to release it from its resting position.
2. Pivot the support leg back through about 180°.
3. Push against the support leg from below until it engages in the retracted position.

## 6.1.2 Extending the support leg



### CAUTION

**Risk of finger injury!** When extending/retracting the support leg there is a risk of trapping the fingers between the scaffold hook and the casing of the tool.

- ▶ Hold the fastening tool by the grip when extending/retracting the support leg.

1. Push against the support leg to release it from its resting position.
2. Pivot the support leg forward through about 180°.
3. Push against the support leg from below until it engages in the extended position.

## 6.2 Switching the fastening tool on/off

### 6.2.1 Switching the fastening tool on



### WARNING

**Risk of injury!** Pressing the nosepiece of the fastening tool against a part of the body may lead to serious injury due to inadvertent firing and release of a fastener.

- ▶ **Never press the nosepiece of the tool against your hand or any other part of the body.**

- ▶ Press the on/off button.
  - ◀ The spring element can be heard to build up tension and the status indicator lights green.



#### Note

When battery performance drops, tensioning of the spring element will take longer than with a fully charged battery.

Battery performance drops at low temperatures.

If you continue to operate the fastening tool after noticing a drop in battery performance, the fastening tool will switch itself off automatically before damage to the battery cells occurs.

### 6.2.2 Switching off the fastening tool

- ▶ Press the on/off button.
  - ◀ The spring element can be heard to release the tension and the status indicator goes out.

### 6.3 Driving a nail

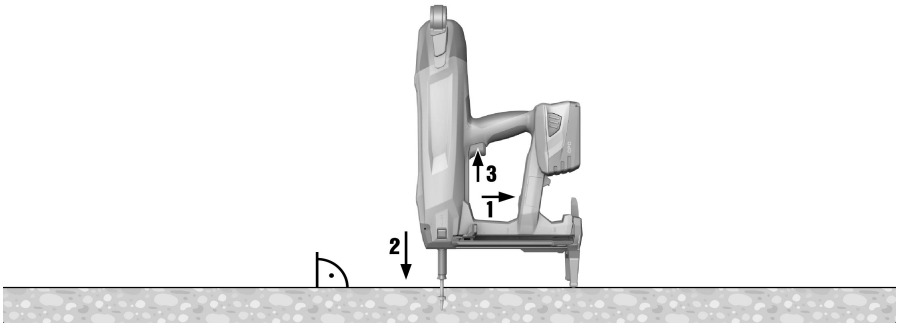

#### WARNING

**Risk of injury by flying parts!** When driving a fastener, there is a risk of injury to the body and eyes caused by splintered fragments of the workpiece and by flying parts of the nail strip.

- ▶ **Wear personal protective equipment and always wear protective glasses and protective gloves.** Other persons in the vicinity must also wear eye protection and a hard hat.



#### WARNING

**Risk of injury!** Pressing the nosepiece of the fastening tool against a part of the body may lead to serious injury due to inadvertent firing and release of a fastener.

- ▶ **Never press the nosepiece of the tool against your hand or any other part of the body.**

1. Switch the fastening tool on. → page 12
2. Position the nose of the fastening tool at right angles to the workpiece and then press it against the surface, pushing the fastener guide in as far as it will go.
3. Drive the nail by pressing the safety trigger.
4. After driving the nail, lift the fastening tool away from the workpiece completely.



#### Note

The fastening tool switches itself off automatically if the fastener guide is pressed against the workpiece for longer than 6 seconds without a nail being driven. The fastening tool can be switched back on again by pressing the on/off button.



#### Note

If the fastening tool is not used for 6 minutes, it switches itself off automatically.

## 6.4 Removing the battery

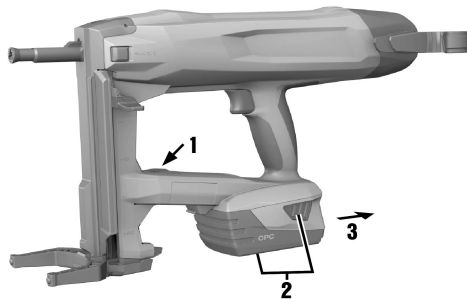

1. Switch the fastening tool off. → page 13
2. Press the two release buttons and hold them in the pressed position.
3. Pull the battery out of the fastening tool to the rear.

## 6.5 Removing nails from the fastening tool

### 6.5.1 Removing a nail when in magazine mode

1. Pull the nail pusher down until it engages.
2. Slide the nail downwards out of the magazine.
3. Hold the nail pusher securely and press the nail pusher release button.
4. Guide the nail pusher back to its original position.

### 6.5.2 Removing a nail when in single-fastener mode

- ▶ To remove a nail that has been inserted into the fastener guide, proceed in the same way as for removing a jammed nail (see → page 14).

## 6.6 Jammed nails

Individual nails may get stuck in the fastener guide. You can remove jammed nails from the fastener guide with the aid of the X-NP drift punch set. Accessories are available from your **Hilti** Center or can be ordered online at [www.hilti.com](http://www.hilti.com).



### WARNING

**There is a risk of injury and damage to the fastening tool.** Use of unsuitable items instead of the recommended genuine **Hilti** accessories may result in injury or damage to the fastening tool.

- ▶ To release a jammed nail, use only the recommended drift punch set.



### CAUTION

**Risk of injury by flying parts!** Triggering the tool (attempting to drive a fastener) when foreign objects are present in the area around the fastener guide, or when a fastener is jammed in the fastener guide, may lead to injury caused by flying objects or fragments.

- ▶ Never attempt to remedy tool malfunctions by continuing to trigger the tool.

### 6.6.1 Releasing jammed nails

1. Remove the fastener guide (see → page 9).
2. Fit the fastener guide into the supporting sleeve from the drift punch set.
3. Use the drift punch and a hammer to drive the jammed nail out of the fastener guide.
4. Fit the fastener guide (see → page 10).



## 7 Care and maintenance

### 7.1 Care of the fastening tool

- ▶ Remove plastic fragments from the fastener guide at regular intervals.
- ▶ Never operate the fastening tool when the air vents are blocked. Clean the air vents carefully using a dry brush.
- ▶ Do not allow foreign objects to enter the interior of the fastening tool.
- ▶ Clean the exterior of the fastening tool with a slightly damp cloth at regular intervals.
- ▶ Do not use a spray, pressure jet washer or running water for cleaning.
- ▶ Keep the grips of the fastening tool dry, clean and free from oil and grease.
- ▶ Do not use cleaning agents containing silicone.

### 7.2 Maintenance

- ▶ To help ensure safe and reliable operation, use only genuine Hilti spare parts and consumables. You can find other spare parts, consumables and accessories approved for this product at your local **Hilti** Center or online at: [www.hilti.com](http://www.hilti.com).

### 7.3 Cleaning the inside of the nosepiece

1. Remove the fastener guide.
2. Clean the inside of the nosepiece.
3. Insert the fastener guide.

## 8 Troubleshooting

If the trouble you are experiencing is not listed in this table or you are unable to remedy the problem by yourself, please contact **Hilti** Service.

### 8.1 Troubleshooting table

Trouble or fault	Possible cause	Action to be taken
The spring element is not tensioned; no status indication.	The battery is empty.	▶ Change the battery.
	The battery is not fitted correctly.	▶ Fit the battery. → page 9
The spring element is not tensioned, the status indicator blinks green and 1 battery charge status LED blinks.	The battery is empty.	▶ Change the battery.
	Battery temperature too low.	▶ Allow the battery to warm up slowly to room temperature.
The spring element is not re-tensioned, the status indicator blinks green and 4 battery charge status LEDs blink.	The fastening tool has overheated.	▶ Allow the fastening tool to cool down.
The spring element is not tensioned and the status indicator blinks red.	The fastener guide is not fitted correctly.	▶ Insert the fastener guide. → page 10
The spring element is not tensioned and the status indicator lights red.	System fault.	▶ Remove the battery. → page 14
		▶ Fit the battery. → page 9
The fastener guide cannot be pressed in and the status indicator lights green.	The magazine is empty.	▶ Load the magazine. → page 10
	The nail pusher is jammed.	▶ Remove the nail strips from the magazine and clean the magazine.
	Nail jammed in the fastener guide.	▶ Release the jammed nail. → page 14
The fastener guide is jammed in the pressed-in state.	Dirt between the fastener guide and the nosepiece.	▶ Clean the inside of the nosepiece. → page 15



### WARNING

**Risk of injury.** Hazards presented by improper disposal.

- ▶ Improper disposal of the equipment may have the following consequences: The burning of plastic components generates toxic fumes which may present a health hazard. Batteries may explode if damaged or exposed to very high temperatures, causing poisoning, burns, acid burns or environmental pollution. Careless disposal may permit unauthorized and improper use of the equipment. This may result in serious personal injury, injury to third parties and pollution of the environment.
- ▶ Dispose of defective batteries right away. Keep them out of reach of children. Do not disassemble or incinerate the batteries.
- ▶ Batteries that have reached the end of their life must be disposed of in accordance with national regulations or returned to **Hilti**.

 Most of the materials from which **Hilti** tools and appliances are manufactured can be recycled. The materials must be correctly separated before they can be recycled. In many countries, your old tools, machines or appliances can be returned to **Hilti** for recycling. Ask **Hilti** Service or your Hilti representative for further information.

## 10 Manufacturer's warranty

- ▶ Please contact your local **Hilti** representative if you have questions about the warranty conditions.





Hilti Corporation

LI-9494 Schaan

Tel.: +423/234 21 11

Fax: +423/234 29 65

[www.hilti.com](http://www.hilti.com)

Hilti = registered trademark of Hilti Corp., Schaan



20160822