

HILTI



Hilti HIT-RE 500 V3 1400 Jumbo

Instruction for use [en](#)

Gebrauchsanweisung [de](#)

Mode d'emploi [fr](#)

Istruzioni per l'uso [it](#)

Instrucciones de uso [es](#)

Instruções de utilização [pt](#)

Handleiding [nl](#)

Οδηγίες χρήσης [el](#)

Kullanma talimatı [tr](#)

取扱説明書 [ja](#)

使用说明 [cn](#)

使用說明書 [zh](#)

사용설명서 [ko](#)

إرشادات الاستخدام [ar](#)

Arahan untuk penggunaan [ms](#)

Hướng dẫn sử dụng [vi](#)

คำแนะนำการใช้งาน [th](#)

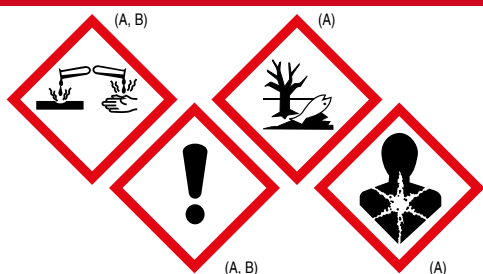

Danger



Contains: 2,2'-[(1-methylethylidene)bis(4,1-phenyleneoxymethylene)]bisoxirane (A); Trimethylolpropane triglycidylether (A); 2-methyl-1,5-pentanediamine (B); m-Xylylenediamine (B);

Causes severe skin burns and eye damage (A, B)

May cause an allergic skin reaction (A, B)

May cause respiratory irritation (B)

Suspected of causing genetic defects (A).

May damage fertility or the unborn child (A)











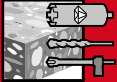





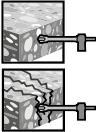
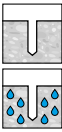
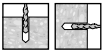



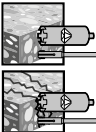

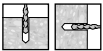



Toxic to aquatic life with long lasting effects (A,B)



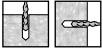

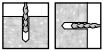
en	Adhesive anchoring system for rebar and anchor fastenings in concrete. Read the safety instructions, general informations and warnings before using the product.	→ 42/43
de	Verbundmörtel für Betoneisen- und Dübelbefestigungen in Beton. Vor der Anwendung die Sicherheitsvorschriften, die allgemeinen Informationen und die Warnhinweise lesen.	→ 44/45
fr	Mortier de scellement pour ancrage de chevilles et d'armatures dans le béton. Avant utilisation, bien lire les prescriptions de sécurité, les informations générales et les indications d'avertissement.	→ 46/47
it	Resina ad iniezione per fissaggi con tondini per cemento armato e con tasselli nel calcestruzzo. Prima di procedere all'utilizzo del prodotto, leggere le norme di sicurezza, le informazioni generali e le avvertenze.	→ 48/49
es	Resina de inyección para la fijación de anclajes y tacos en hormigón. Lea las indicaciones de seguridad, la información general y las advertencias antes de utilizar el producto.	→ 50/51
pt	Buchas químicas para fixações de ferros e de ancoragens em betão. Antes da aplicação, ler a ficha de segurança, as informações gerais e as advertências.	→ 52/53
nl	Ankermortel voor bevestiging van betonijzer en pluggen in beton. Vóór het gebruik de veiligheidsvoorschriften, de algemene informatie en de waarschuwingen lezen.	→ 54/55
el	Χημικό αγκύριο για στερεώσεις αναμονών οπλισμού και κοχλιών αγκύρωσης σε σκυρόδεμα. Πριν από τη χρήση, διαβάστε τις προδιαγραφές ασφαλείας, τις γενικές πληροφορίες και τις υποδείξεις προειδοποίησης.	→ 56/57
tr	Beton demiri ve dübelleri beton içerisinde sabitlenmesi için bağlantı harcı. Uygulamadan önce güvenli yöntemlerini, genel bilgileri ve uyarı bilgilerini okuyunuz.	→ 58/59
ja	コンクリート用接着系注入方式アンカー。ご使用前に、「安全上のご注意」、「一般的な注意」および「警告」をお読みください。	→ 60/61
cn	用于在混凝土中固定钢筋和锚的胶粘剂锚固系统。使用产品前，请阅读安全说明、一般信息和警告。	→ 62/63
zh	用於混凝土中固定鋼筋及安卡的黏著安卡系統。使用產品前，請先閱讀安全說明、一般使用說明和警語。	→ 64/65
ko	콘크리트 고정용 철근 및 핀 연결 모르타르 시스템. 사용하기 전에 작업 시 안전규칙, 일반 정보 및 경고 사항을 숙독한다.	→ 66/67
ar	ملاط تثبيت لأعمال تثبيت أسياخ الحديد والخوابير في الخرسانة. احرص قبل الاستخدام على قراءة تعليمات الأمان والمعلومات العامة والإرشادات التحذيرية.	→ 68/69
ms	Sistem penambatan perekat untuk bar tetulang dan pengikatan penambatan dalam konkrit. Baca arahan keselamatan, maklumat umum dan amaran sebelum menggunakan produk.	→ 70/71
vi	Hệ thống neo cấy dùng keo để củng cố cốt thép và neo cấy vào bê tông. Vui lòng đọc các hướng dẫn an toàn, thông tin tổng quát và cảnh báo trước khi sử dụng sản phẩm.	→ 72/73
th	ระบบกาวเคมีสำหรับติดยึดเหล็กเสริมและสลักในคอนกรีต โปรดอ่านคำแนะนำนำด้านความปลอดภัย ขอมูลทั่วไป และคำเตือนก่อนใช้งานผลิตภัณฑ์	→ 74/75

1			14...55 mm	70...250 mm		
2			14...55 mm	70...3200 mm		
3						
4			14...40 mm	70...250 mm		
5			14...40 mm	70...640 mm		
6			14...40 mm	70...640 mm		
7			14...35 mm	70...250 mm		

									
8			14...35 mm	70...1000 mm					
9									
10			18...35 mm	80...250 mm					
11						18...35 mm	80...600 mm		
12									
13			14...55 mm	110...250 mm					
14						14...55 mm	70...640 mm		
15									



en	Dry concrete	Water saturated concrete	Waterfilled borehole in concrete	Submerged borehole in concrete
de	Trockener Beton	Wassergesättigter Beton	Wassergefülltes Bohrloch in Beton	Unterwasser-Bohrloch in Beton
fr	Béton sec	Béton saturé d'eau	Trou dans le béton rempli d'eau	Trou dans le béton immergé
it	Calcestruzzo secco	Calcestruzzo saturo d'acqua	Foro pieno d'acqua nel calcestruzzo	Foro sott'acqua nel calcestruzzo
es	Hormigón seco	Hormigón saturado de agua	Taladro lleno de agua en hormigón	Taladro sumergido en hormigón
pt	Betão seco	Betão saturado de água	Furo em betão cheio de água	Furo debaixo de água em betão
nl	Droog beton	Met water verzadigd beton	Met water gevuld boorgat in beton	Boorgat in beton onder water
el	Στεγνό σκυρόδεμα	Σκυρόδεμα κορεσμένο με νερό	Οπή διάτρησης με νερό σε σκυρόδεμα	Υποβρύχια οπή διάτρησης μέσα σε σκυρόδεμα
tr	Kuru beton	Suya doyurulmuş beton	Beton içerisinde su ile doldurulmuş delik	Beton içerisinde su akıtma kanalı deliği
ja	乾式コンクリート	湿式コンクリート	コンクリート内の水の溜まった穿孔穴	水中のコンクリート内の穿孔穴
cn	干燥混凝土	水饱和混凝土	装有水的混凝土钻孔	水下混凝土钻孔
zh	乾燥混凝土	水飽和混凝土	混凝土中有充滿水的孔洞	混凝土中藏有孔洞
ko	건식 콘크리트	습식 콘크리트	콘크리트 속에 물이 차 있는 천공구멍	수중 콘크리트 속 천공구멍
ar	الخرسانة الجافة	الخرسانة المشبعة بالماء	تقب محفور في الخرسانة ممتلئ بالماء	تقب محفور في الخرسانة تحت الماء
ms	Konkrit kering	Konkrit ditepu air	Lubang jara diisikan air dalam konkrit	Lubang jara di bawah permukaan air dalam konkrit
vi	Bê tông khô	Bê tông đủ nước	Lỗ khoan chứa nước trong bê tông	Lỗ khoan chìm trong bê tông
th	คอนกรีตแห้ง	คอนกรีตอึมน้ำ	รูเจาะในคอนกรีตที่มีน้ำข้าง	รูเจาะในคอนกรีตที่จมอยู่ใต้น้ำ



en	Hammer drilling	Diamond coring	Hollow drill bit	Roughening tool
de	Hammerbohren	Diamantbohren	Hohlbohrer	Aufrauwerkzeug
fr	Perçage avec percussion	Forage au diamant	Foret creux	Outil de rugosification
it	Foratura con percussione	Foratura con punta diamantata	Punta cava	Utensile di irruvidimento
es	Taladrado con martillo	Taladrado con diamante	Taladro con broca hueca y aspiración	Útil de rugosidad
pt	Perfurar de martelo	Perfurar com equipamento diamantado	Broca de coroa oca	Ferramenta de rugosidade
nl	Boorhameren	Diamantboren	Holle boor	Opruwgereedschap
el	Κρουστική διάτρηση	Διάτρηση με διαμάντι	Κρουστικό δράπανο	Εξάρτημα εκτρέχυσης
tr	Darbeli delme	Elmas delme	Oyuk matkap ucu	Taşlama aleti
ja	打撃穿孔	ダイヤモンドコアドリルによる穿孔	ホロードリルビット	ラフニング工具
cn	锤击钻孔	金刚石取芯钻孔	空心钻头	粗加工工具
zh	鎚擊鑽孔	鑽石鑽心鑽孔	空心钻头	粗化工具
ko	함마 드릴링	다이아몬드 드릴링	동공드릴 비트	황삭기
ar	التعب بالطرق	التعب الماسي	ريشة تعب التجاويف	أداة تخشين
ms	Pengerudian tukul	Penerasan berlian	Bit gerudi geronggang	Alat pengasaran
vi	Khoan bằng búa	Khoan bằng kim cương	Mũi khoan lỗ rỗng	Công cụ làm nhám
th	การเจาะกระแทก	การคว้านด้วยเครื่องมือเพชร	ดอกสว่านเจาะแบบกลวง	เครื่องมือขัดทราย



en	Threaded rod Threaded sleeve	Rebar	Uncracked concrete	Cracked concrete
de	Gewindestange Gewindehülse	Bewehrungseisen	Ungerissener Beton	Gerissener Beton
fr	Varilla roscada Manguito roscado	Barras corrugadas para armado	Hormigón no fisurado	Hormigón fisurado
it	Asta filettata Manicotto filettato	Ferri di armatura	Calcestruzzo non fessurato	Calcestruzzo fessurato
es	Tige fileté Douille fileté	Armature métallique	Béton non lézardé	Béton lézardé
pt	Barra roscada Casquilho roscado	Ferros de armadura	Betão não fissurado	Betão fissurado
nl	Draadeind Schroefmof	Wapeningsstaal	Niet-gescheurd beton	Gescheurd beton
el	Βέργα με σπειρώμα Χιτώνιο με σπειρώμα	Σίδερο οπλισμού	Σκυρόδεμα χωρίς ρηγματώσεις	Σκυρόδεμα με ρηγματώσεις
tr	Dişli çubuk Dişli manşon	Takviye demirleri	Çatlamaş beton	Çatlamış beton
ja	ネジ付きロッド 細型 スリーブ	鉄筋	亀裂のないコンクリート	亀裂の入ったコンクリート
cn	全牙螺杆螺纹套环	钢筋	未破裂混凝土	破裂混凝土
zh	全牙螺杆 螺纹套环	鋼筋	未破裂混凝土	破裂混凝土
ko	나사 로드 나사 슬리브	철근	비균열 콘크리트	균열 콘크리트
ar	القضيب المولوب الجلبة المولوية	قضبان حديد التسليح	الخرسانة غير المتشققة	الخرسانة المتشققة
ms	Rod berulir Sarung berulir	Batang Penulangan	Konkrit tidak retak	Konkrit retak
vi	Thanh ren Ống lồng có ren	Cốt thép	Bê tông chưa nứt	Bê tông nứt
th	แท่งเกลียว ปลอกเกลียว	เหล็กเส้น	คอนกรีตส่วนที่รับแรงอัด	คอนกรีตส่วนที่รับแรงดึง



t_{work}



$t_{cure, ini}$



$t_{cure, full}$



$t_{roughen}$

en	Working time	Initial curing time	Curing time	Roughening time
de	Verarbeitungszeit	Montagefestigkeit	Aushärtezeit	Aufrauzeit
fr	Temps de manipulation	Stabilité du montage	Temps de durcissement	Temps de rugosification
it	Tempo di lavorazione	Resistenza di montaggio	Tempo di indurimento	Tempo di irruvidimento
es	Tiempo de tratamiento	Resistencia de montaje	Tiempo de fraguado	Tiempo de rugosidad
pt	Tempo de trabalho	Resistência de montagem	Tempo de cura total	Tempo de rugosidade
nl	Verwerkingstijd	Montagesterkte	Uithardingstijd	Opruwtijd
el	Χρόνος επεξεργασίας	Αντοχή τοποθέτησης	Χρόνος εφαρμογής φορτίων	Χρόνος εκτράχυνσης
tr	İşleme süresi	Montaj dayanıklılığı	Sertleşme süresi	Taşlama süresi
ja	ゲル状時間	初期養生時間	硬化時間	ラフニング時間
cn	工作时间	初部固化时间	固化时间	粗加工时间
zh	工作時間	初部固化時間	固化時間	粗化時間
ko	가공시간	설치강도	경화시간	황삭가공시간
ar	فترة التحضير	متانة التركيب	مدة التصلب	مدة التخشين
ms	Masa bekerja	Masa pengawetan permulaan	Masa pengawetan	Masa pengasaran
vi	Thời gian làm việc	Thời gian đông cứng ban đầu	Thời gian đông cứng hoàn toàn	Thời gian làm nhám
th	ระยะเวลาในการทำงาน	ระยะเวลาในการแข็งตัวเริ่มต้น	ระยะเวลาในการแข็งตัว	ระยะเวลาในการขัดหยาบ

HAS-U, -HDG, -A4, -HCR / HIT-V, -F, -R / HAS / HAS-E

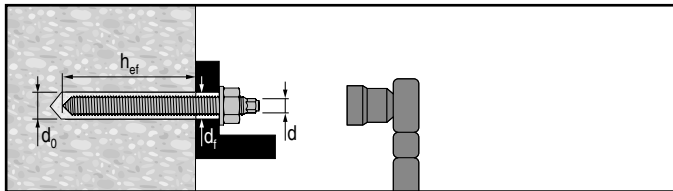



HIT-V

 $\varnothing d$ [mm]	$\varnothing d_0$ [mm]	h_{ef} [mm]	$\varnothing d_f$ [mm]	T_{max} [Nm]
M12	14	70...240	14	40
M16	18	80...320	18	80
M20	22	90...400	22	150
M24	28	100...480	26	200
M27	30	110...540	30	270
M30	35	120...600	33	300

1 inch = 25,4 mm

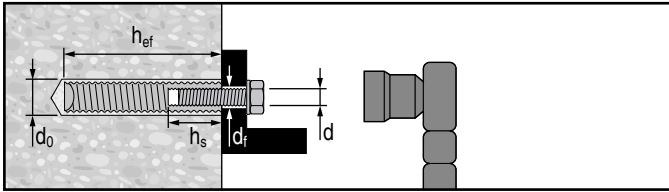
HIS (-N, -RN)

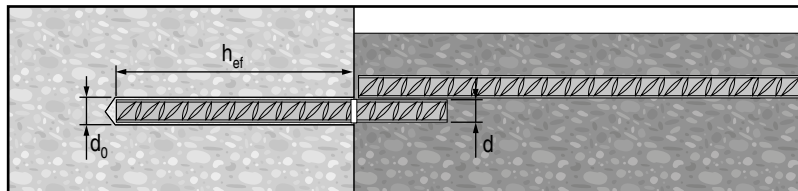

 $\varnothing d$ [mm]	$\varnothing d_0$ [mm]	h_{ef} [mm]	$\varnothing d_f$ [mm]	h_s [mm]	T_{max} [Nm]
M8	14	90	9	8...20	10
M10	18	110	12	10...25	20
M12	22	125	14	12...30	40
M16	28	170	18	16...40	80
M20	32	205	22	20...50	150

Rebar

Rebar

 $\varnothing d$ [mm]	$\varnothing d_0$ [mm]	h_{ef} [mm]
12	14	...1200
14	18	...1400
16	20	...1600
18	22	...1800
20	25	...2000
22	28	...2200
24	32	...2400
25	32	...2500
26	35	...2600
28	35	...2800
30	37	...3000
32	40	...3200
36	45	...3200
40	55	...3200

Ø		HAS-U HIT-V	HIS-N	Rebar	HIT-RB	HIT-SZ	HIT-DL	TE-YRT
d ₀ [mm]		d [mm]			[mm]	[mm]	[mm]	[mm]
14	14*	12	8	10	14	14	14	
16	16	-	-	12	16	16	16	
18	18	16	10	14	18	18	18	18
20	20	-	-	16	20	20	20	20
22	22	20	12	18	22	22	20	22
25	25	-	-	20	25	25	25	25
28	28	24	16	22	28	28	25	28
30	30	27	-	-	30	30	25	30
32	32	-	20	24/25	32	32	32	32
35	35	30	-	26/28	35	35	32	35
37	-	-	-	30	37	37	32	
40	-	-	-	32	40	40	32	

HIT-DL: h_{ef} > 250 mm

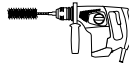
HIT-RB: h_{ef} > 20 x d







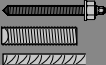

TE-CD 14: min. 61 l/s VC 20/40-Y no battery mode

Hilti VC 20/40 (-Y)		HIT-OHC		HIT-OHW
	Ø d ₀ [mm]	HIT-...	Art. No.	Art. No.
min. 57 l/s	14 ... 20	OHC 1	387551	387550
	22 ... 32	OHC 2	387552	

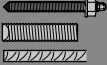
d ₀ [mm]	[mm]	Art. No. 381215	
...32	...1500	✓	≥ 6 bar/90 psi
...55	...3200	-	≥ 140 m³/h

Hilti HIT-RE 500 V3 1400 Jumbo



				
[°C]	 t_{work}	 $t_{cure, ini}$	 $t_{cure, full}$	[°F]
-5 ... -1	2 h	48 h	168 h	23 ... 31
0 ... 4	2 h	24 h	48 h	32 ... 40
5 ... 9	2 h	16 h	24 h	41 ... 49
10 ... 14	1.5 h	12 h	16 h	50 ... 58
15 ... 19	1 h	8 h	16 h	59 ... 67
20 ... 24	30 min	4 h	7 h	66 ... 76
25 ... 29	20 min	3.5 h	6 h	77 ... 85
30 ... 34	15 min	3 h	5 h	86 ... 94
35 ... 39	12 min	2 h	4.5 h	95 ... 103
40	10 min	2 h	4 h	104



$\geq +5\text{ °C} / 41\text{ °F}$



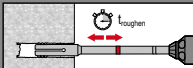

$= 2x\ t_{cure}$

	 t_{trowen}
h_{ef} [mm]	
0 ... 100	10 sec
101 ... 200	20 sec
201 ... 300	30 sec
301 ... 400	40 sec
401 ... 500	50 sec
501 ... 600	60 sec

$$t_{trowen} = h_{ef} \text{ [mm]} / 10$$

 Rebar - $h_{ef} \geq 20d$



		h_{ef}		
HIT-P 8000D	...40mm	...3200mm	-5 °C ... 40 °C 23 °F ... 104 °F	5 °C ... 40 °C 41 °F ... 104 °F



		h_{ef}		
HIT-P 8000D	...28mm	...1000mm	-5 °C ... 40 °C 23 °F ... 104 °F	5 °C ... 40 °C 41 °F ... 104 °F

1

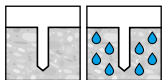
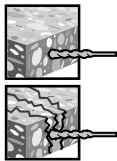

d_0 :
14...55 mm

h_{ef} :
70...250 mm

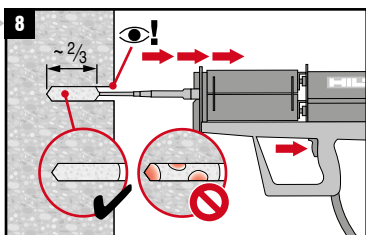
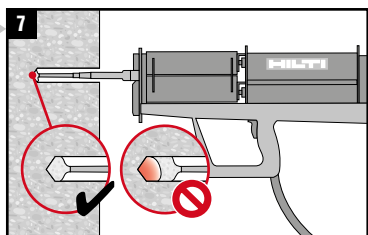
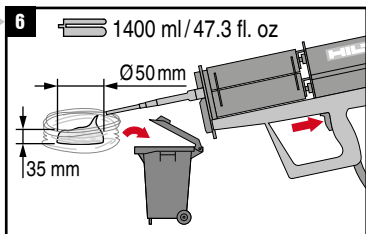
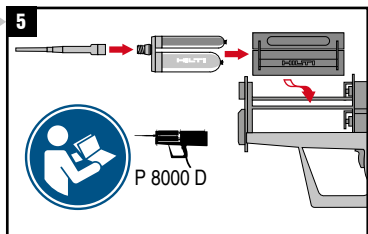
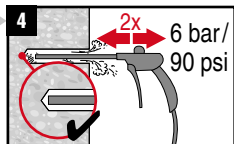
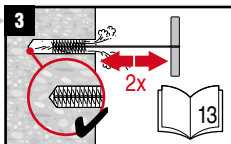
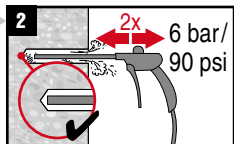
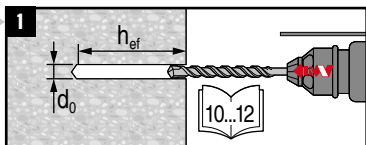
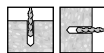

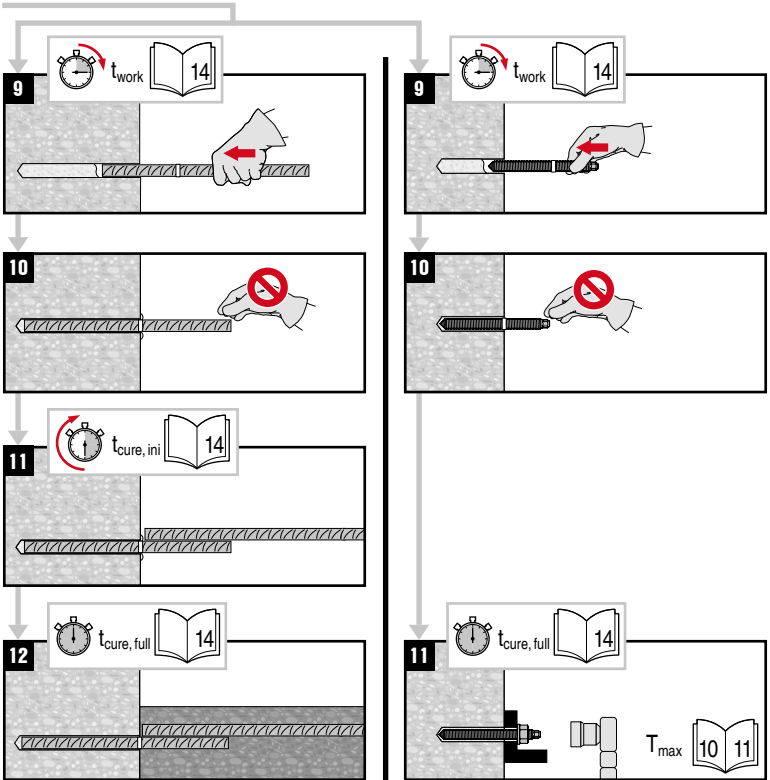

2

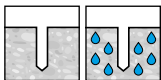
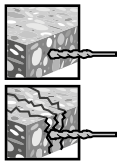

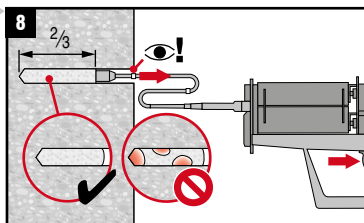
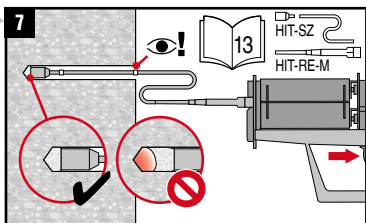
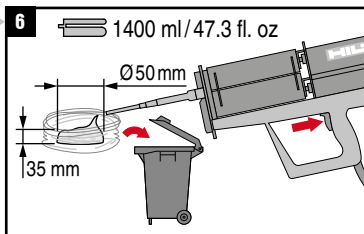
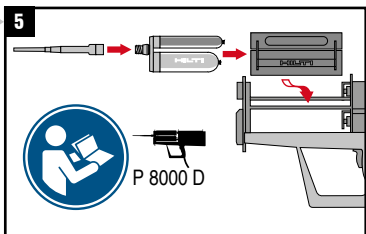
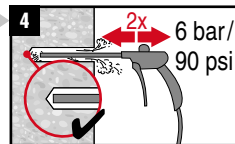
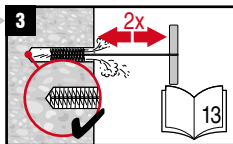
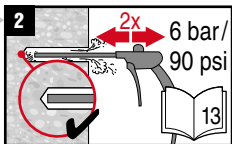
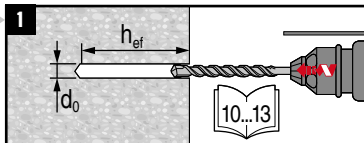
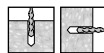
 d_0 :
14...55 mm

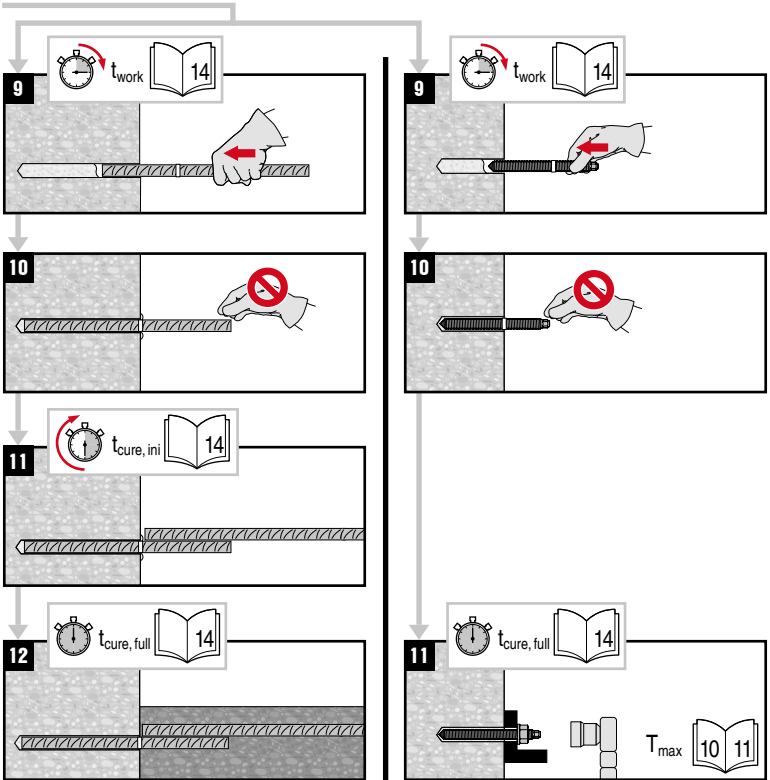
 h_{ef} :
70...3200 mm

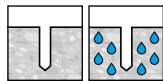
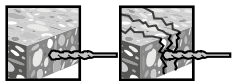

3

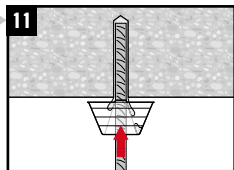
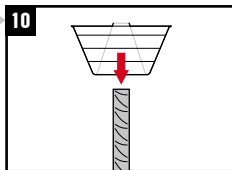
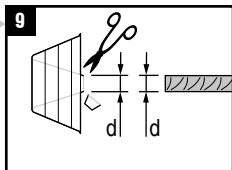
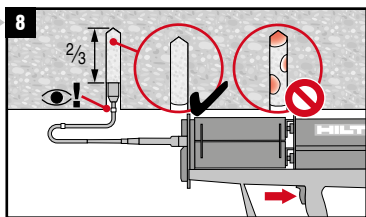
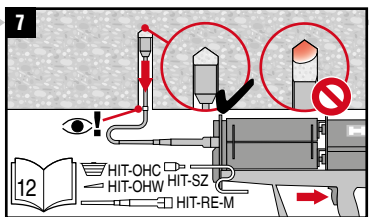
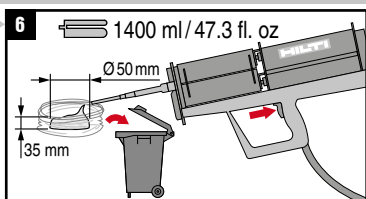
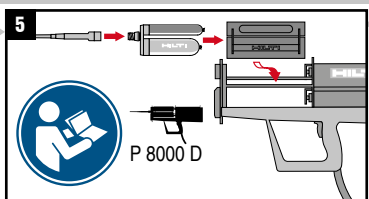
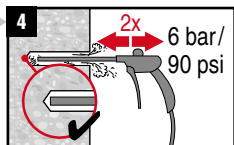
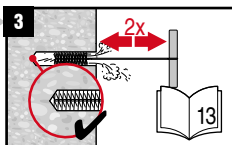
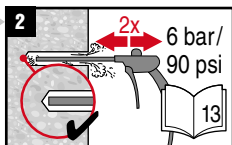
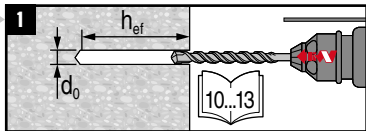
 d_0 :
14...55 mm

 h_{ef} :
70...3200 mm

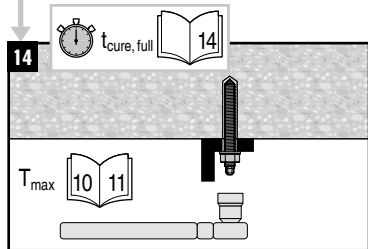
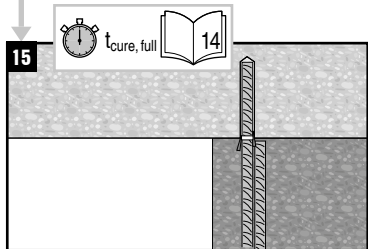
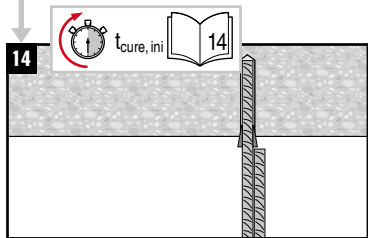
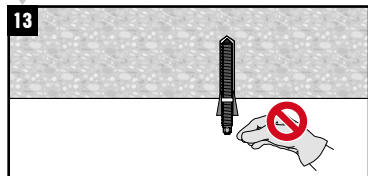
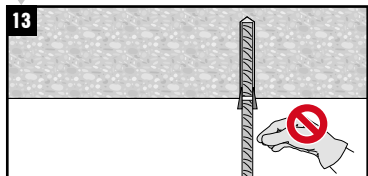
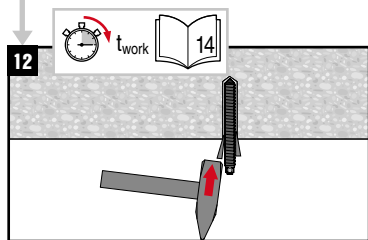
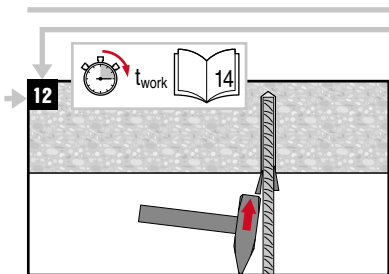

4

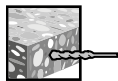

d_0 :
14...40 mm

h_{ef} :
70...250 mm

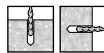

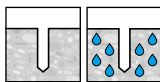
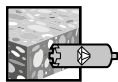

13

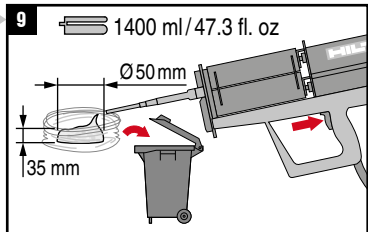
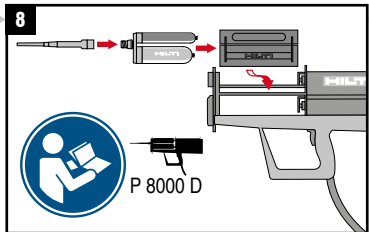
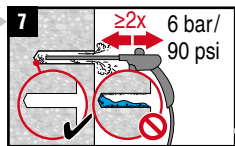
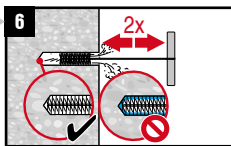
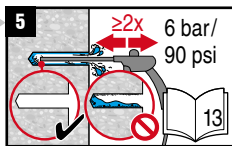
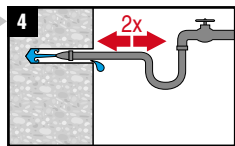
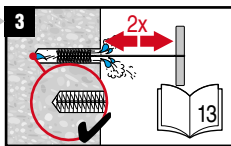
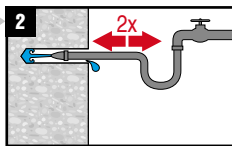
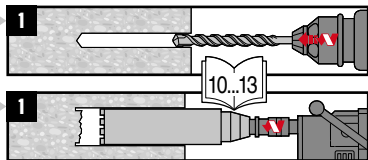

d_0 :
14...52 mm

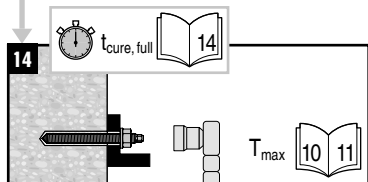
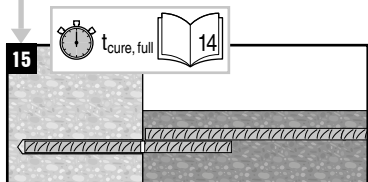
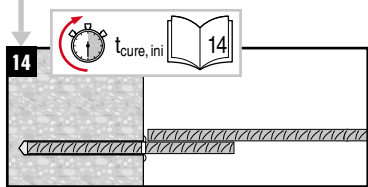
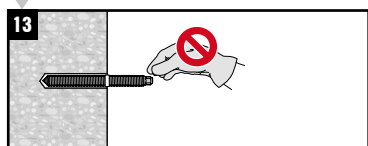
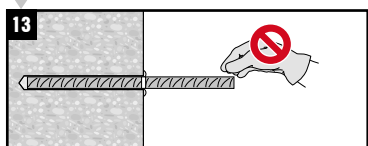
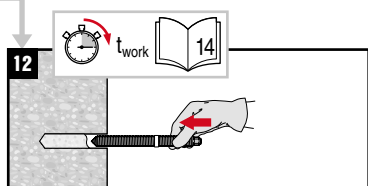
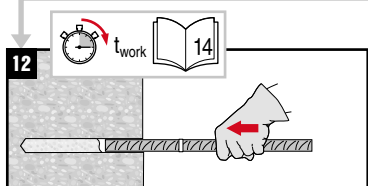
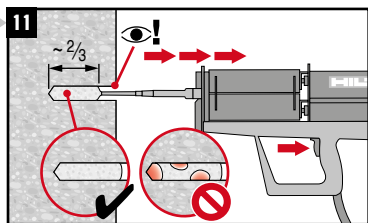
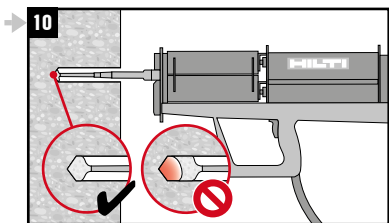

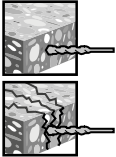

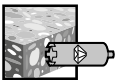
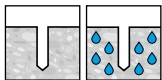
5			d_0 : 14...40 mm	h_{ef} : 70...640 mm	
	14			d_0 : 14...52 mm	

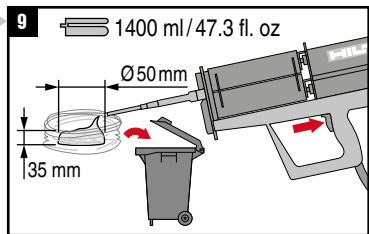
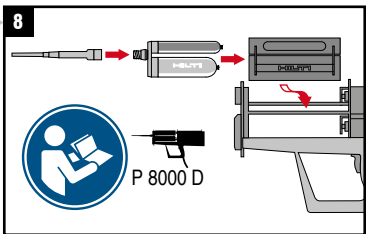
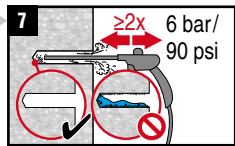
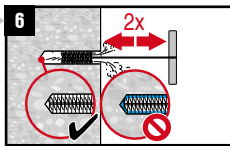
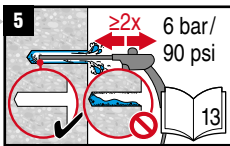
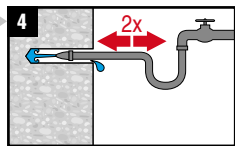
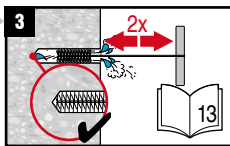
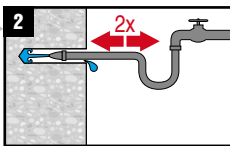
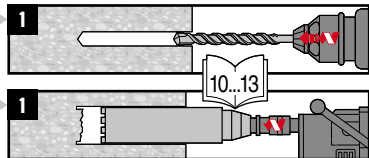

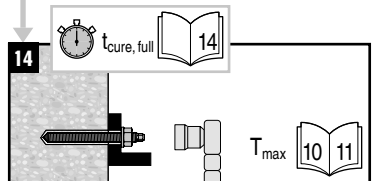
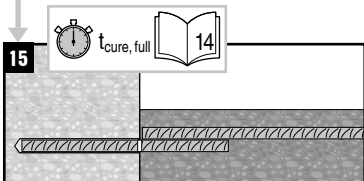
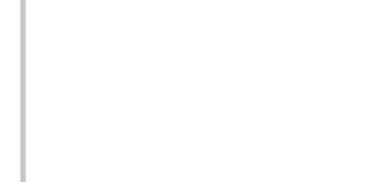
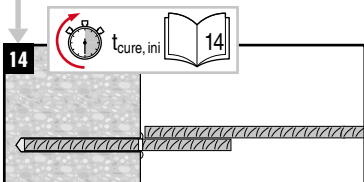
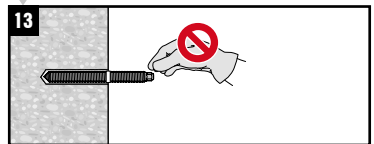
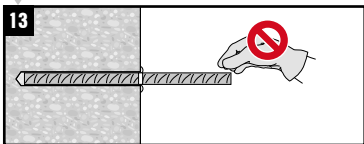
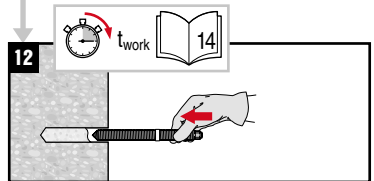
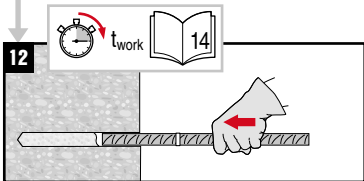
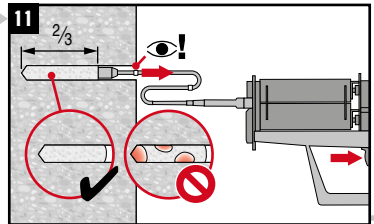
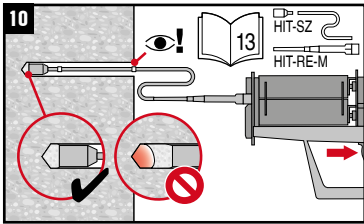

6



d_0 :
14...40 mm

h_{ef} :
70...640 mm

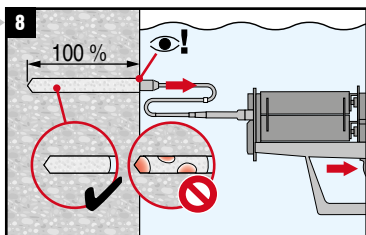
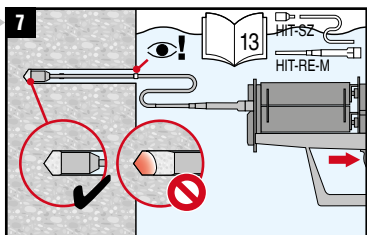
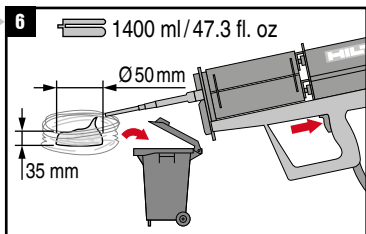
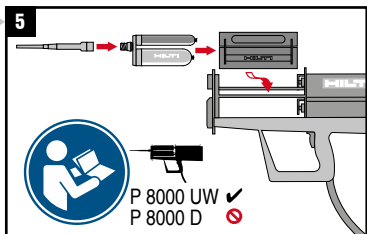
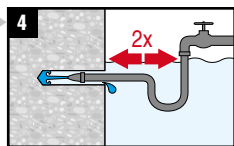
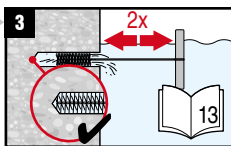
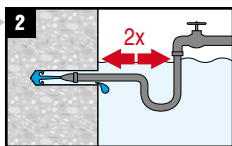
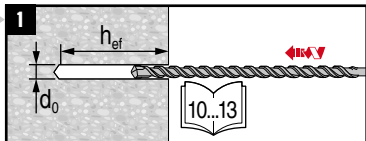
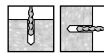

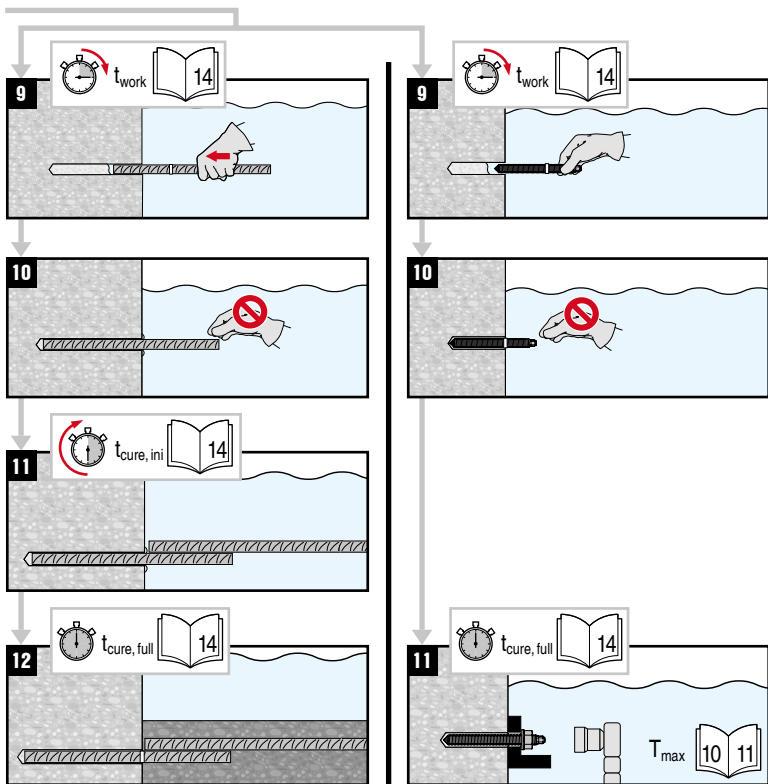

7

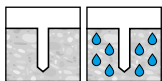
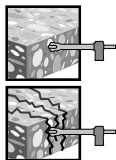

d_0 :
14...35 mm

h_{ef} :
70...250 mm

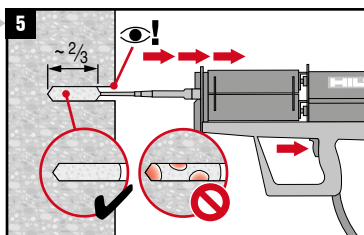
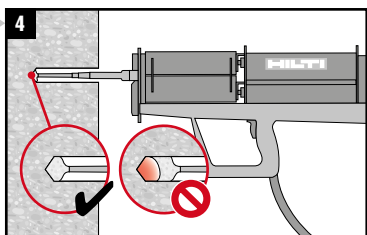
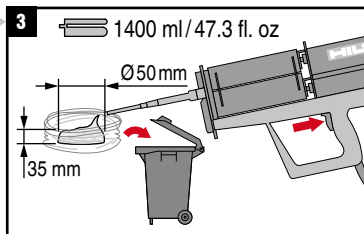
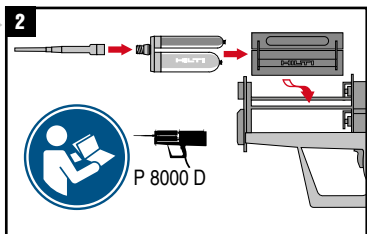
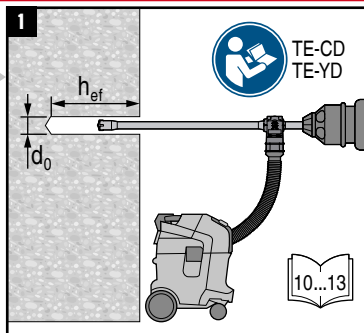
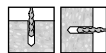

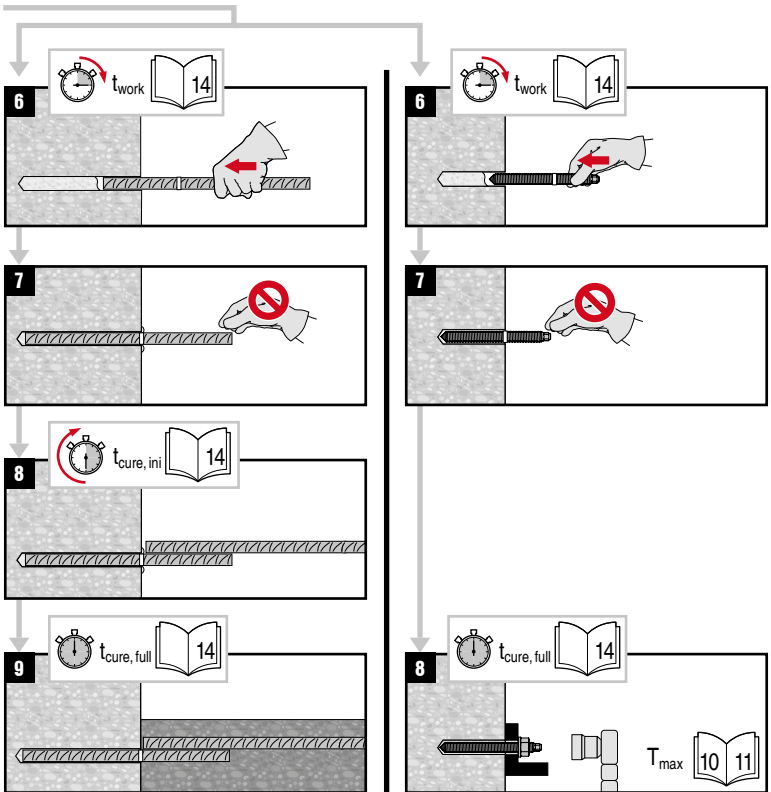

8

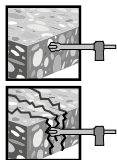

d_0 :
14...35 mm

h_{ef} :
70...1000 mm

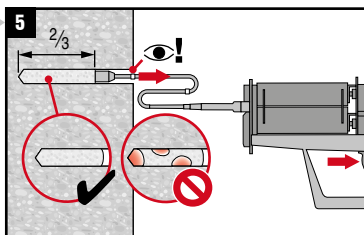
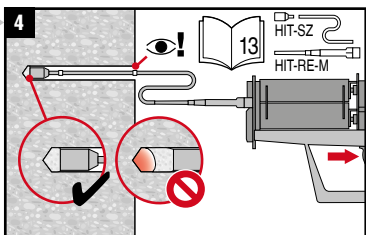
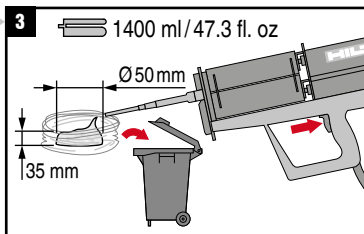
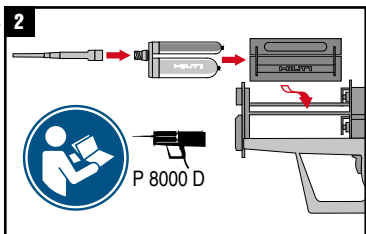
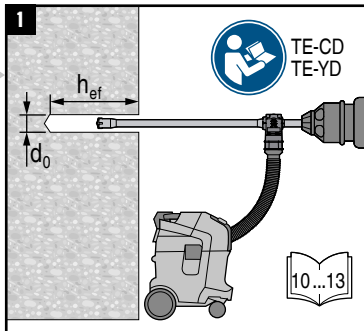
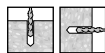

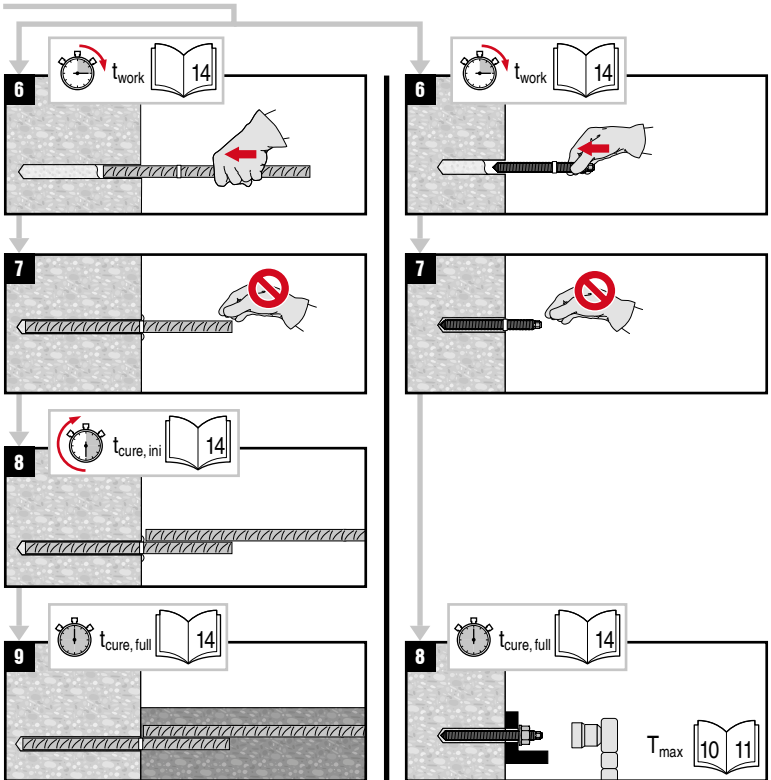

9

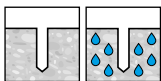
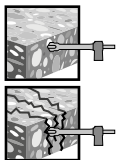
 d_0 :
14...35 mm

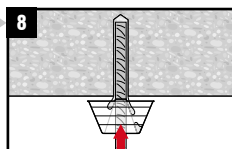
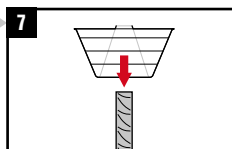
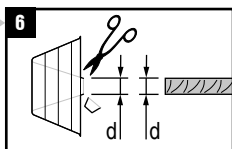
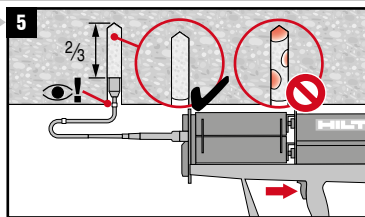
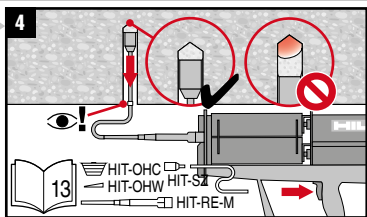
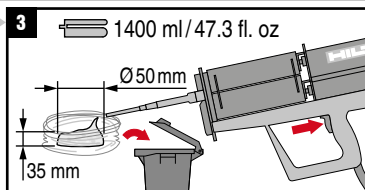
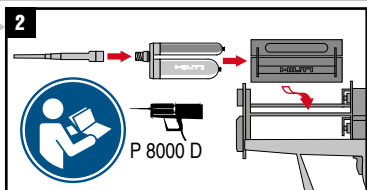
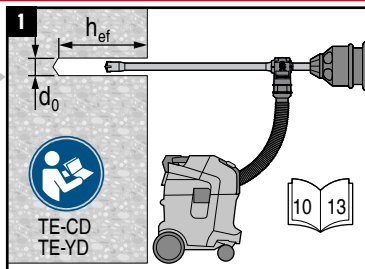
 h_{ef} :
70...1000 mm

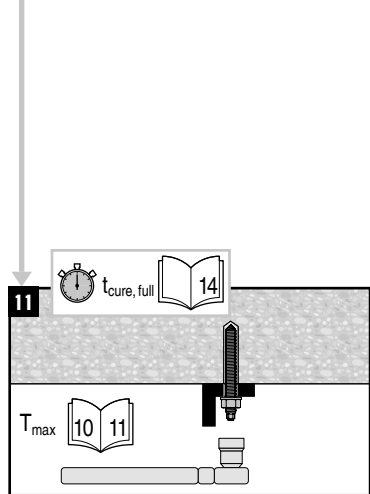
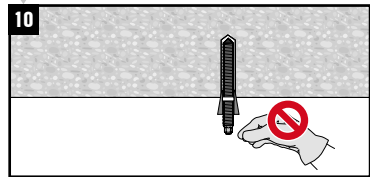
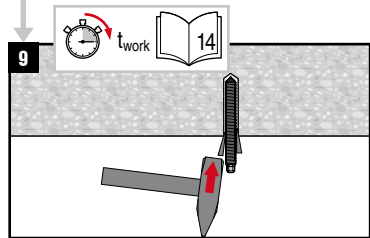
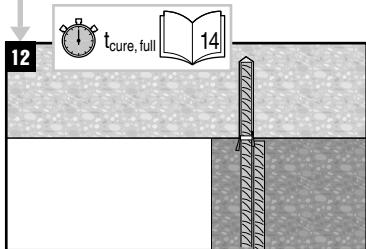
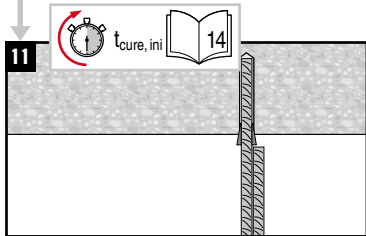
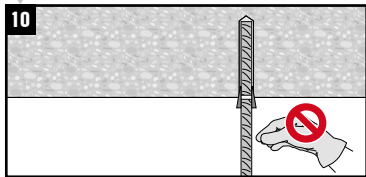
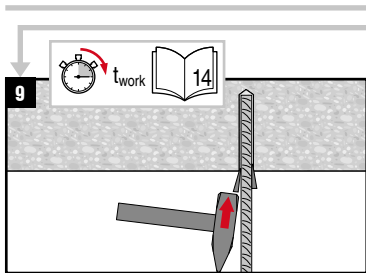

10

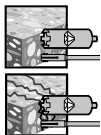

d_0 :
18...35 mm

h_{ef} :
80...250 mm

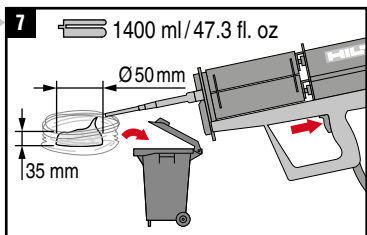
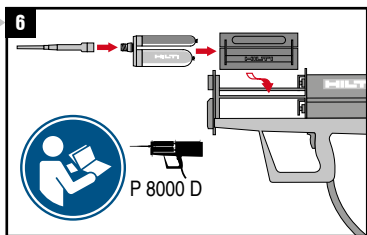
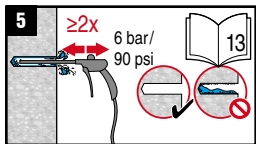
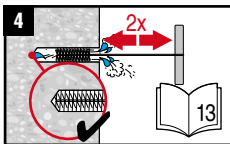
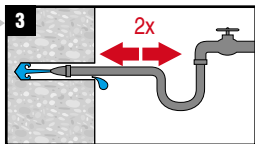
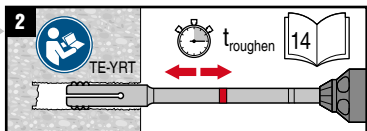
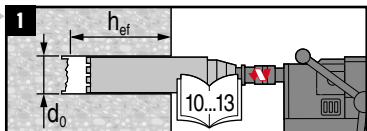
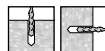

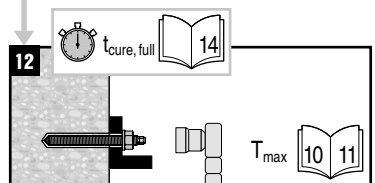
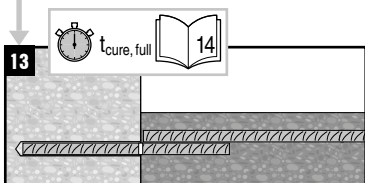
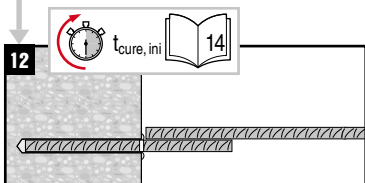
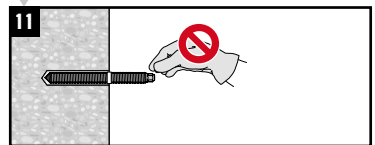
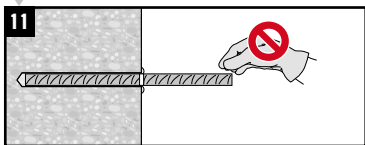
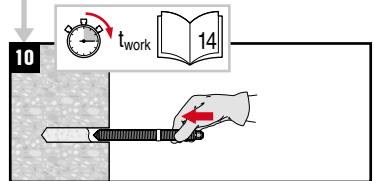
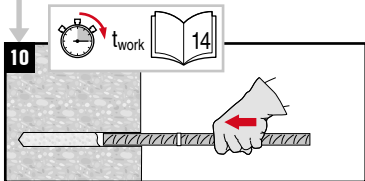
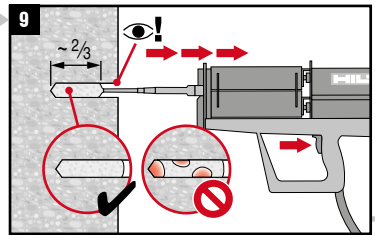
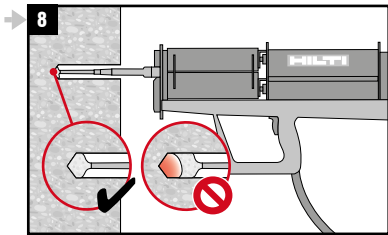

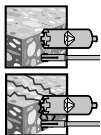

d_0 :
18...35 mm

h_{ef} :
80...600 mm

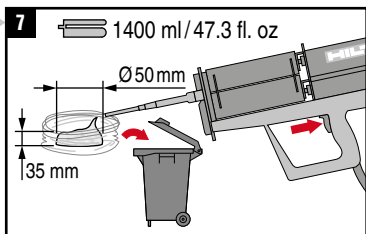
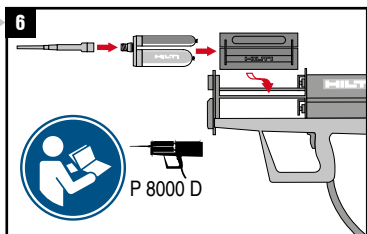
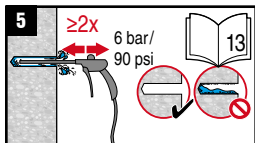
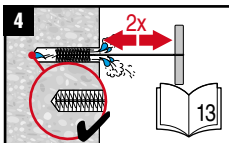
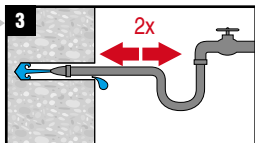
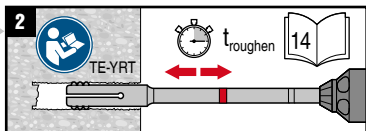
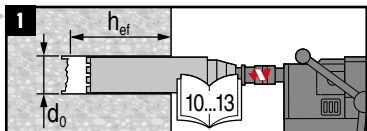
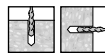

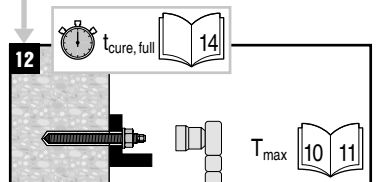
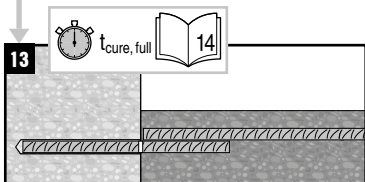
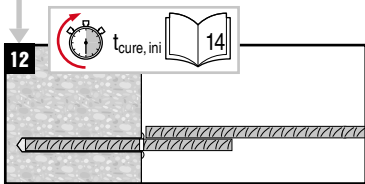
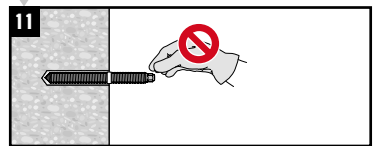
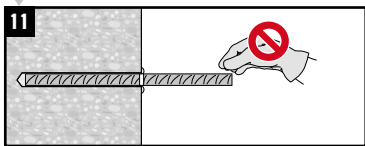
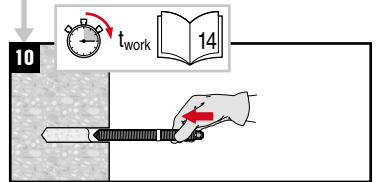
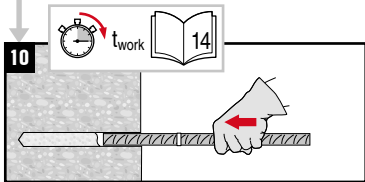
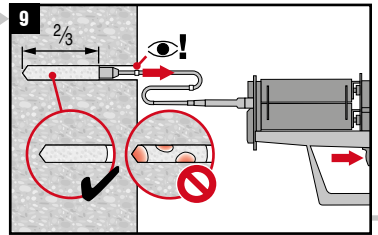
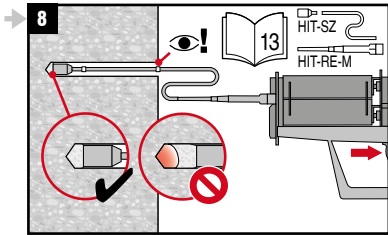

12

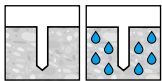
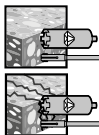

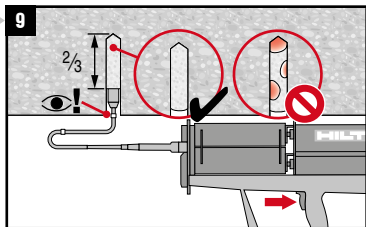
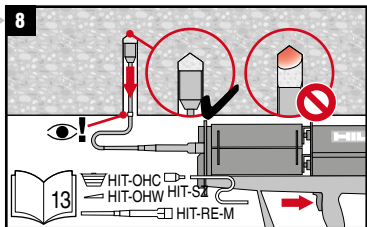
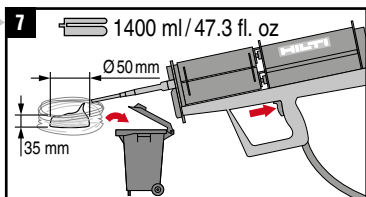
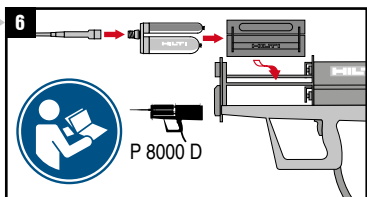
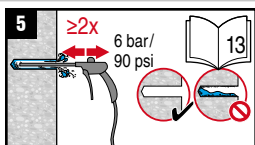
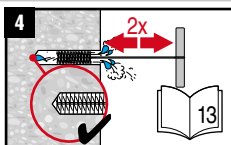
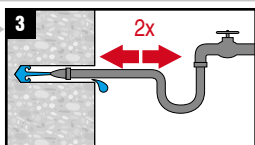
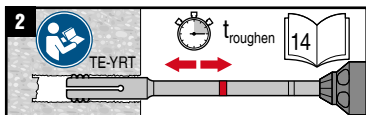
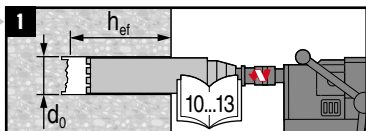
 d_0 :
18...35 mm

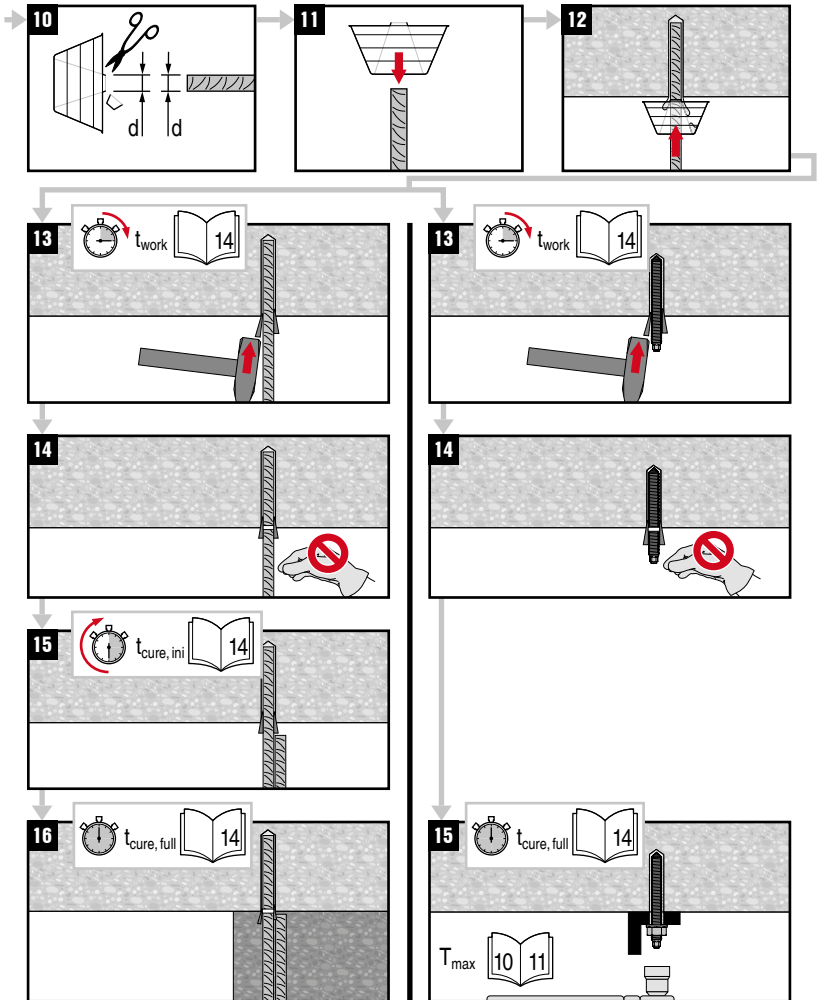
 h_{ef} :
80...600 mm

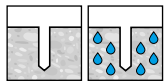
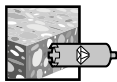

15

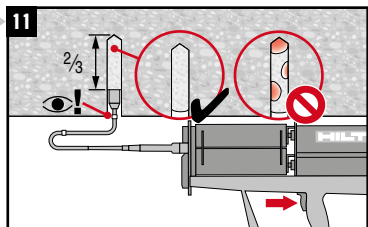
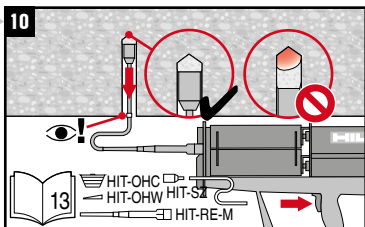
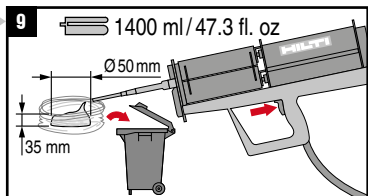
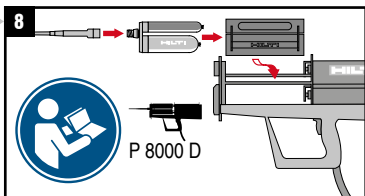
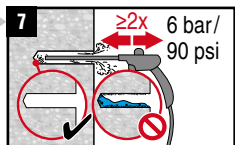
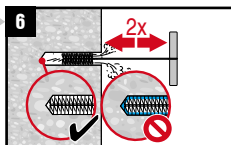
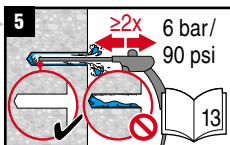
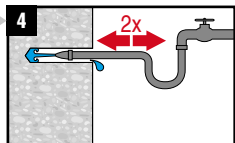
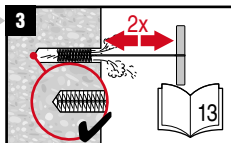
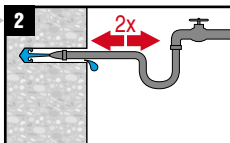
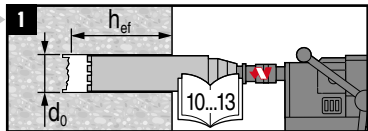
 d_0 :
14...52 mm

 h_{ef} :
70...3200 mm

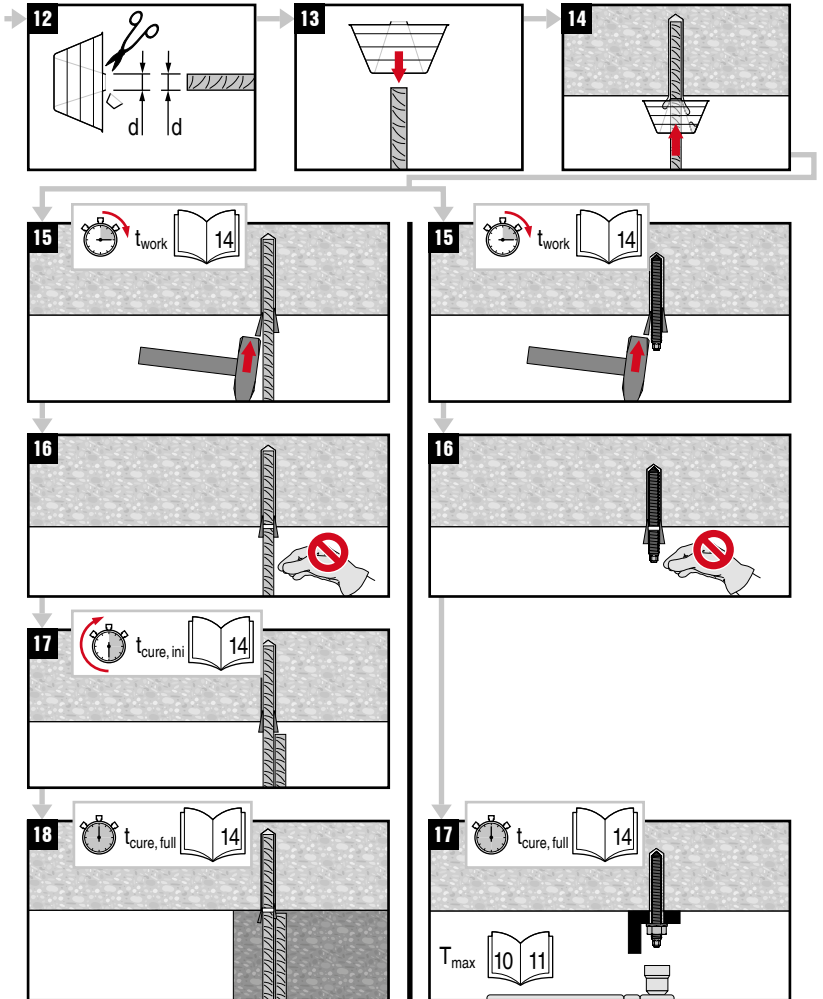

Adhesive anchoring system for rebar and anchor fastenings in concrete

- ▶ Prior to use of product, follow the instructions for use and the legally obligated safety precautions.
- ▶ See the Safety Data Sheet for this product.

Hilti HIT-RE 500 V3

Contains: 2,2'-[(1-methylethylidene)bis(4,1-phenyleneoxymethylene)]bisoxirane (A); Trimethylolpropane triglycidylether (A); 2-methyl-1,5-pentanediamine (B); m-Xylylenediamine (B);



Danger

- H314 Causes severe skin burns and eye damage.(A,B)
H317 May cause an allergic skin reaction.(A,B)
H335 May cause respiratory irritation (B)
H341 Suspected of causing genetic defects (A)
H360 May damage fertility or the unborn child (A)
H411 Toxic to aquatic life with long lasting effects.(A,B)

P280 Wear protective gloves/protective clothing/eye protection/face protection.

P262 Do not get in eyes, on skin, or on clothing

P302+P352 IF ON SKIN: Wash with plenty of soap and water.

P305+P351+P338 IF IN EYES: Rinse cautiously with water for several minutes. Remove contact lenses, if present and easy to do. Continue rinsing.

P333+P313 If skin irritation or rash occurs: Get medical advice/attention.

P337+P313 If eye irritation persists: Get medical advice/attention.

Recommended protective equipment:

Eye protection: Tightly sealed safety glasses e.g.: #02065449 Safety glasses PP EY-CA NCH clear; #02065591 Goggles PP EY-HA R HC/AF clear;

Protective gloves: EN 374 ; Material of gloves: Nitrile rubber, NBR

Avoid direct contact with the chemical/ the product/ the preparation by organizational measures.

Final selection of appropriate protective equipment is in the responsibility of the user

Disposal considerations

Empty packs:

- ▶ Leave the Mixer attached and dispose of via the local Green Dot collecting system
 - or EAK waste material code 15 01 02 plastic packaging.



Full or partially emptied packs:

- ▶ dispose of as special waste in accordance with official regulations.
 - EAK waste material code: 20 01 27* paint, inks, adhesives and resins containing dangerous substances.
 - or waste material code: EAK 08 04 09* waste adhesives and sealants containing organic solvents or other dangerous substances.

Content: 1400 ml / 47.3 fl.oz

Weight: 1980 g / 69.8 oz

Warranty: Refer to standard Hilti terms and conditions of sale for warranty information.

Failure to observe these installation instructions, use of non-Hilti anchors, poor or questionable concrete conditions, or unique applications may affect the reliability or performance of the fastenings.

Product Information

- Always keep this instruction for use together with the product.
- Ensure that the instruction for use is with the product when it is given to other persons.
- **Safety Data Sheet:** Review the SDS before use.
- **Check expiration date:** See expiration date imprint on foilpack manifold (month/year). Do not use expired product.
- **Foil pack temperature during usage:** +5 °C to 40 °C / 41 °F to 104 °F.
- **Conditions for transport and storage:** Keep in a cool, dry and dark place between +5 °C to 25 °C / 41 °F to 77 °F.
- For any application not covered by this document / beyond values specified, please contact Hilti.
- **Partly used foil packs must be used up within one week.** Leave the mixer attached on the foil pack manifold in the dispenser and do not retract the pistons! Remove the air pressure hose and store under the recommended storage conditions. If reused, attached a new mixer and discard the initial quantity of anchor adhesive.

WARNING



⚠ Improper handling may cause mortar splashes. Eye contact with mortar may cause irreversible eye damage!

- Always wear tightly sealed safety glasses, gloves and protective clothes before handling the mortar!
- Never start dispensing without a mixer properly screwed on.
- When using an extension hose: Discard of initial mortar flow must be done through supplied mixer only (not through the extension hose).
- Attach a new mixer prior to dispensing a new foil pack (snug fit).
- Caution! Never remove the mixer while the foil pack system is under pressure.
- Use only the type of mixer supplied with the adhesive. Do not modify the mixer in any way.
- Dropping foil packs, also foil packs already inserted into the foil pack holder, is likely to cause damage leading to mal function.
- Never use damaged foil packs and/or damaged or unclean foil pack holders.

⚠ Poor load values / potential failure of fastening points due to inadequate borehole cleaning. The boreholes must be dry and free of debris, dust, water, ice, oil, grease and other contaminants prior to adhesive injection.

- Hilti hollow drill bits TE-CD, TE-YD must be used in conjunction with a properly maintained Hilti vacuum cleaner with model and suction capacity (volumetric flow rate) as specified in the accessory table.
- For blowing out the borehole - blow out with oil free air until return air stream is free of noticeable dust.
- For flushing the borehole - flush with water line pressure until water runs clear.
- Important! Remove all water from the borehole and blow out with oil free compressed air until borehole is completely dried before mortar injection (not applicable to hammer drilled hole in underwater application).

⚠ Ensure that boreholes are filled from the back of the boreholes without forming air voids.

- If necessary, use the accessories / extensions to reach the back of the borehole.
- For overhead applications use the overhead accessories HIT-SZ / IP and take special care when inserting the fastening element. Excess adhesive may be forced out of the borehole. Make sure that no mortar drips onto the installer.
- If a new mixer is installed onto a previously-opened foil pack, the first trigger pulls must be discarded.

⚠ Not adhering to these setting instructions can result in failure of fastening points.

Verbundmörtel für Betoneisen- und Dübelbefestigungen in Beton

- ▶ Vor der Verwendung diese Gebrauchsanleitung lesen und die Sicherheitsvorschriften einhalten.
- ▶ Sicherheitsdatenblatt des Produkts beachten.

Hilti HIT-RE 500

Enthält: 2,2-Bis(4-hydroxyphenyl)propan-bis(2,3-epoxypropyl)ether (A); Trimethylolpropantriglycidylether (A); 2-methyl-1,5-pentanediamine (B); m-Xylylenediamin (B);

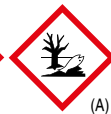
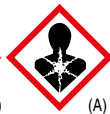

Gefahr

- | | |
|------|--|
| H314 | Verursacht schwere Verätzungen der Haut und schwere Augenschäden.(A, B) |
| H317 | Kann allergische Hautreaktionen verursachen.(A,B) |
| H335 | Kann die Atemwege reizen (B) |
| H341 | Kann vermutlich genetische Defekte verursachen. (A) |
| H360 | Kann die Fruchtbarkeit beeinträchtigen oder das Kind im Mutterleib schädigen (A) |
| H411 | Giftig für Wasserorganismen, mit langfristiger Wirkung.(A,B) |

- | | |
|----------------|--|
| P280 | Schutzhandschuhe/Schutzkleidung/Augenschutz/Gesichtsschutz tragen. |
| P262 | Nicht in die Augen, auf die Haut oder auf die Kleidung gelangen lassen |
| P302+P352 | BEI KONTAKT MIT DER HAUT: Mit viel Wasser und Seife waschen |
| P305+P351+P338 | BEI KONTAKT MIT DEN AUGEN: Einige Minuten lang behutsam mit Wasser spülen. Vorhandene Kontaktlinsen nach Möglichkeit entfernen. Weiter spülen. |
| P333+P313 | Bei Hautreizung oder -ausschlag: Ärztlichen Rat einholen/ärztliche Hilfe hinzuziehen. |
| P337+P313 | Bei anhaltender Augenreizung: Ärztlichen Rat einholen/ärztliche Hilfe hinzuziehen |

Empfehlung zur persönlichen Schutzausrüstung:

Augenschutz: Dichtschließende Schutzbrille z.B. #02065449 Sicherheitsbrille PP EY-CA NCH klar; #2065591 Schutzbrille PP EY-HA R HC/AF klar;

Schutzhandschuhe: EN 374; Handschuhmaterial: Nitrilkauschuk, NBR

Der direkte Kontakt mit der Chemikalie/dem Produkt/der Zubereitung ist durch organisatorische Maßnahmen zu vermeiden.

Die endgültige Auswahl der geeigneten Schutzausrüstung liegt in der Verantwortung des Anwenders.

Hinweise zur Entsorgung

Entleerte Gebinde:

- ▶ Den Mischer aufgeschraubt lassen und über das nationale Sammelsystem Grüner Punkt entsorgen
– oder EAK-Abfallcode: 15 01 02 Verpackungen aus Kunststoff.



Volle oder teilweise leerte Gebinde:

- ▶ Unter Beachtung der behördlichen Vorschriften als Sonderabfall entsorgen.
 - EAK-Abfallcode: 20 01 27* Farben, Druckfarben, Klebstoffe und Kunstharze, die gefährliche Stoffe enthalten.
 - oder EAK-Abfallcode: 08 04 09* Klebstoff- und Dichtmassenabfälle, die organische Lösemittel oder andere gefährliche Stoffe enthalten.

Inhalt: 1400 ml / 47.3 fl.oz

Gewicht: 1980 g / 69.8 oz

Gewährleistung: Gewährleistungsinformationen siehe allgemeine Verkaufsbedingungen von Hilti.

Das Nichtbeachten dieser Montageanleitung, das Verwenden von Hilti-fremden Ankern, schlechte oder zweifelhafte Betoneigenschaften sowie Spezialanwendungen können Zuverlässigkeit und Leistung der Befestigungen beeinträchtigen.

de

Produktinformation

- Bewahren Sie diese Gebrauchsanweisung immer zusammen mit dem Produkt auf.
- Geben Sie das Produkt nur zusammen mit der Gebrauchsanweisung an andere Personen weiter.
- **Sicherheitsdatenblatt:** Vor der Arbeit das SDB beachten.
- **Haltbarkeitsdatum:** Das Haltbarkeitsdatum (Monat/Jahr) auf dem Verbindungsteil des Gebindes prüfen. Produkt darf nach Ablauf nicht mehr verwendet werden.
- **Gebindetemperatur während des Gebrauchs:** +5 °C bis 40 °C / 41 °F bis 104 °F.
- **Transport- und Lagerungsbedingungen:** kühl, trocken und dunkel bei +5 °C bis 25 °C / 41 °F bis 77 °F.
- Bei Anwendungen, die nicht in vorliegender Gebrauchsanweisung beschrieben werden oder außerhalb der Spezifikationen liegen, wenden Sie sich bitte an Hilti.
- **Nicht vollständig aufgebrauchte Foliengebände müssen innerhalb von einer Woche weiterverarbeitet werden.** Dazu das Gebinde mit aufgeschraubtem Mischer im Auspressgerät belassen und den Druck nicht zurückfahren. Gerät von der Druckversorgung abkoppeln und vorschriftsmäßig lagern. Vor Weiterverwendung einen neuen Mischer aufschrauben und erneut den Mörtelvorlauf verwerfen.

WARNUNG



⚠ Bei unsachgemäßer Handhabung ist Spritzen des Mörtels möglich. Augenkontakt mit dem Mörtel kann blühende Augenschäden verursachen!

- Bei der Arbeit eine dicht schließende Schutzbrille, Schutzhandschuhe und Arbeitskleidung tragen!
- Nie ohne ordnungsgemäß aufgeschraubten Mischer mit dem Auspressen beginnen!
- Beim Einsatz eines Verlängerungsschlauchs: Mörtelvorlauf nur durch den gelieferten Mischer verwerfen (nicht durch den Verlängerungsschlauch).
- Vor dem Auspressen eines neuen Foliengebundes einen neuen Mischer aufschrauben. Auf festen Sitz achten.
- Vorsicht! Niemals den Mischer abschrauben, wenn das System unter Druck steht.
- Ausschließlich den mit dem Mörtel gelieferten Mischertyp verwenden. Den Mischer unter keinen Umständen verändern.
- Kontrollieren, ob das Foliengebände und die Kassette unbeschädigt sind – insbesondere, nachdem sie heruntergefallen sind! Heruntergefallene Gebinde, auch wenn sie bereits in der Kassette eingelegt waren, können zu Fehlfunktionen führen.
- Niemals beschädigte Foliengebände und/oder beschädigte oder verschmutzte Kassetten verwenden.

⚠ Schlechte Haltewerte/Versagen der Befestigung durch unzureichende Bohrlöcherreinigung. Vor der Injektion müssen die Bohrlöcher trocken und frei von Bohrklein, Staub, Wasser, Eis, Öl, Fett oder anderen Verunreinigungen sein.

- Die Hilti Hohlbohrer TE-CD und TE-YD müssen in Verbindung mit einem fachgerecht gewarteten Hilti Staubsauger eingesetzt werden. Angaben zu geeigneten Modellen und zur Saugleistung (Volumenstrom) entnehmen Sie der Zubehörtabelle.
- Ausblasen des Bohrlochs – das Bohrloch mit ölfreier Luft ausblasen, bis die rückstömende Luft staubfrei ist.
- Ausspülen des Bohrlochs – mit Wasserschlauch bei normalem Leitungsdruck ausspülen bis klares Wasser abfließt.
- Wichtig! Vor dem Verfüllen mit Mörtel das Wasser aus dem Bohrloch entfernen und mit ölfreier Druckluft ausblasen, bis es vollständig trocken ist (nicht anwendbar bei hammergebohrten Bohrlöchern in der Unterwasser-Anwendung).

⚠ Sicherstellen, dass die Bohrlöcherfüllung vom Bohrlochgrund aus erfolgt, damit keine Luftblasen gebildet werden.

- Wenn notwendig dafür die Verlängerungen verwenden, um den Bohrlochgrund zu erreichen.
- Bei Überkopf-Anwendungen das Zubehör HIT-SZ/IP verwenden und besonders beim Einführen des Befestigungselementes anpassen. Überschüssiger Mörtel kann aus dem Bohrloch austreten. Sicherstellen, dass kein Mörtel auf den Anwender tropft.
- Wird ein neuer Mischer auf ein bereits geöffnetes Foliengebände aufgeschraubt, die ersten Hülbe ebenfalls verwerfen.

⚠ Nichtbeachtung der Anweisungen kann zum Versagen der Befestigung führen!

Mortier de scellement pour ancrage de chevilles et d'armatures dans le béton

- ▶ Avant toute utilisation, bien lire le présent mode d'emploi ainsi que les directives de sécurité qui y sont mentionnées.
- ▶ Se reporter à la Fiche de données de sécurité.

Hilti HIT-RE 500 V3

Contient: produit de réaction: 2,2-bis[p-(2,3-époxypropoxy)phényl]propane (A); Triméthylolpropane triglycidylether (A); 2-méthyl-1,5-pentanediamine (B); 1,3-Benzènediméthanimine (B);



(A,B)



(A,B)



(A)

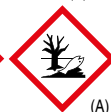

(A)



Danger

H314 Provoque des brûlures de la peau et des lésions oculaires graves.(A,B)

H317 Peut provoquer une allergie cutanée.(A,B)

H335 Puede irritar las vías respiratorias (B)

H341 Susceptible d'induire des anomalies génétiques. (A)

H360 Peut nuire à la fertilité ou au fœtus (A)

H411 Toxique pour les organismes aquatiques, entraîne des effets néfastes à long terme.(A,B)

P280 Porter des gants de protection/des vêtements de protection/un équipement de protection des yeux/du visage.

P262 Éviter tout contact avec les yeux, la peau ou les vêtements

P302+P352 EN CAS DE CONTACT AVEC LA PEAU: laver abondamment à l'eau et au savon.

P305+P351+P338 EN CAS DE CONTACT AVEC LES YEUX: rincer avec précaution à l'eau pendant plusieurs minutes. Enlever les lentilles de contact si la victime en porte et si elles peuvent être facilement enlevées.Continuer à rincer.

P333+P313 En cas d'irritation ou d'éruption cutanée: consulter un médecin.

P337+P313 Si l'irritation oculaire persiste: consulter un médecin.

Équipement de protection recommandé :

Protection des yeux : Lunettes de protection hermétiques p. ex. : réf. 02065449 Lunettes de sécurité PP EY-CA NCH claires ; réf. 02065591 Masque de protection PP EY-HA R HC/AF clair ;

Protection des mains : EN 374 Éviter un contact direct avec le produit chimique / le produit / la préparation à l'aide de mesures d'organisation.

Le choix final de l'équipement de protection adéquat relève de la seule responsabilité de l'utilisateur.

Indications de recyclage

Emballages vides

- ▶ Laisser la buse mélangeuse vissée et procéder à l'élimination par le biais du système de collecte national Point Vert.
 - ou code déchets EAK : 15 01 02 Emballages en plastique.

Emballages pleins/à moitié vides :

- ▶ Les apporter à un centre de collecte des matières dangereuses conformément aux dispositions administratives.
 - Code déchets EAK : 20 01 27* Peintures, encres d'impression, colles et résines artificielles, contenant des substances dangereuses.
 - ou code déchets EAK : 08 04 09* Résidus de colles et composants pour joints, contenant des solvants organiques ou d'autres substances dangereuses.

Contenu : 1400 ml / 47.3 fl.oz

Poids : 1980 g / 69.8 oz



Garantie: pour tous détails concernant la garantie, consulter les conditions de vente Hilti.

Le non respect de ces instructions de pose, l'utilisation de chevilles autres qu'Hilti, la pose dans un béton faible ou matériau ou des applications particulières peuvent avoir un impact sur la sécurité et la performance de la fixation.

Information produit

- Le présent mode d'emploi doit toujours être conservé avec le produit.
- Ne pas donner le produit à un autre utilisateur sans lui fournir le mode d'emploi.
- **Fiche de données de sécurité :** Avant toute utilisation, prendre connaissance des informations de sur les matériaux.
- **Date de péremption :** Contrôler la date de péremption (mois/année) imprimée sur le raccord de la cartouche. Ne plus utiliser un produit dont la date de péremption est dépassée.
- **Température des recharges en cours d'utilisation :** de +5 °C à 40 °C / 41 °F à 104 °F.
- **Conditions de transport et de stockage :** dans un endroit frais, sec et à l'abri de la lumière à une température de +5 °C à 25 °C / 41 °F à 77 °F.
- En cas d'applications qui ne sont pas décrites dans le présent mode d'emploi ou hors plage de valeurs spécifiées, s'adresser à Hilti.
- **Les cartouches souples entamées doivent être réutilisées dans les quatre semaines.** Pour ce faire, laisser la cartouche souple avec l'embout mélangeur vissé dans le pistolet à injecter et ne pas faire revenir en arrière le piston de compression. Désolidariser l'alimentation en pression et stocker conformément à la réglementation. Avant réutilisation, visser une nouvelle buse mélangeuse et à nouveau, jeter le mortier extrudé lors des premières pressions.

AVERTISSEMENT



▲ En cas de manement non conforme, il y a risque de projection du mortier. Tout contact des yeux avec le mortier peut entraîner des lésions irréversibles !

- Lors du travail, porter une protection des yeux étanche, des gants et des vêtements de protection !
- Ne jamais commencer l'extraction si la buse mélangeuse n'est pas vissée !
- Lorsque vous utilisez le tube prolongateur: la première décharge de la résine doit se faire à partir du mélangeur (et non pas du tube prolongateur flexible).
- Avant de commencer l'extrusion d'une nouvelle cartouche souple, visser une nouvelle buse mélangeuse. Vérifier qu'elle est bien en place.
- Attention ! Ne jamais dévisser la buse mélangeuse lorsque le système est sous pression.
- Utiliser exclusivement le type de mélangeur fourni avec le mortier. Ne modifier la buse mélangeuse en aucun cas.
- Vérifier que la cartouche souple et le porte-cartouches ne sont pas endommagés – en particulier, s'ils sont tombés ! Les cartouches qui sont tombées, même si elles avaient déjà été placées dans le porte-cartouches, risquent de provoquer des dysfonctionnements.
- Ne jamais utiliser de cartouches souples endommagées ni de porte-cartouches endommagés/très encrassés.

▲ Mauvaise fixation/défaillance du chevillage à cause d'un nettoyage insuffisant du trou foré. Avant de procéder à l'injection, s'assurer que le trou foré est exempt de débris de perçage, poussières, eau, glace, huile, graisse ou autres contaminants.

- Les mèches creuses Hilti TE-CD, TE-YD doivent être associées à un modèle d'aspirateur Hilti bien entretenu d'une capacité d'aspiration (débit volumétrique) conforme à la spécification du tableau des accessoires.
- Soufflage du trou foré – souffler avec de l'air comprimé exempt d'huile, jusqu'à ce que l'air sortant soit exempt de toute poussière.
- Rinçage du trou foré – rincer le trou à l'eau à pression de conduite normale jusqu'à ce que de l'eau propre ressorte.
- Important ! Avant de remplir de mortier, évacuer l'eau du trou foré et le souffler avec de l'air comprimé exempt d'huile jusqu'à ce qu'il soit entièrement sec (Ne convient pas au trou forés au perforateur à percussion lors d'applications subaquatiques).

▲ Veiller à ce que le remplissage se fasse à partir du fond du trou foré pour éviter la formation de bulles d'air.

- Si nécessaire, utiliser des prolongateurs pour atteindre le fond du trou.
- En cas d'applications au plafond, utiliser l'accessoire HIT-SZ/IP et faire particulièrement attention lors de l'introduction de l'élément de fixation. L'excédent de mortier peut ressortir du trou foré. Veiller alors à ce que celui-ci ne goutte pas sur l'opérateur.
- Si une nouvelle buse mélangeuse est utilisée avec une cartouche déjà entamée, jeter également les premières pressions de mortier extrudé.

▲ Le non-respect des instructions peut entraîner une défaillance du chevillage!

Resina ad iniezione per fissaggi con tondini per cemento armato e con tasselli nel calcestruzzo

- ▶ Prima dell'utilizzo, leggere le presenti Istruzioni per l'uso ed attenersi alle norme di sicurezza.
- ▶ Consultare la scheda tecnica dati di sicurezza di questo prodotto.

Hilti HIT-RE 500 V3

Contiene: prodotto di reazione: 2,2-bis-[4-(2,3-epossipropossi)fenil]-propano (A); Trimethylolpropane triglycidylether (A); 2-methyl-1,5-pentanediamine (B); 1,3-benzendimetanammina (B);



(A,B)



(A,B)



(A)

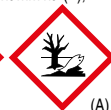

(A)



Pericolo

- H314 Provoca gravi ustioni cutanee e gravi lesioni oculari.(A,B)
H317 Può provocare una reazione allergica cutanea.(A,B)
H335 Può irritare le vie respiratory (B)
H341 Sospettato di provocare alterazioni genetiche. (A)
H360 Può nuocere alla fertilità o al feto (A)
H411 Tossico per gli organismi acquatici con effetti di lunga durata.(A,B)

P280 Indossare guanti/indumenti protettivi/Proteggere gli occhi/il viso.
P262 Evitare il contatto con gli occhi, la pelle o gli indumenti.

P302+P352 IN CASO DI CONTATTO CON LA PELLE: lavare abbondantemente con acqua e sapone.
P305+P351+P338 IN CASO DI CONTATTO CON GLI OCCHI: sciacquare accuratamente per parecchi minuti. Togliere le eventuali lenti a contatto se è agevole farlo. Continuare a sciacquare.

P333+P313 In caso di irritazione o eruzione della pelle: consultare un medico.

P337+P313 Se l'irritazione degli occhi persiste, consultare un medico.

Raccomandazioni sull'equipaggiamento di protezione personale:

Protezione degli occhi: occhiali protettivi, ad es. #02065449 occhiali di protezione PP EY-CA NCH (chiar); #2065591 occhiali protettivi PP EY-HA R HC/AF (chiar);

Guanti protettivi: EN 374; materiale dei guanti: gomma nitrilica, NBR

Evitare, mediante ausilio di provvedimenti organizzativi, il contatto diretto con sostanze chimiche/prodotto/preparati.

L'utilizzatore è responsabile della scelta definitiva dell'equipaggiamento di protezione adeguato.

Avvertenze per lo smaltimento

Confezioni vuote:

- ▶ Lasciare il miscelatore avvitato e procedere allo smaltimento mediante i sistemi nazionali di raccolta dei rifiuti, i punti verdi, ecc.
 - oppure codice rifiuto EAK: 15 01 02 imballaggi in plastica.



Confezioni piene/parzialmente vuote:

- ▶ Procedere allo smaltimento in conformità alle normative ufficiali, come rifiuto speciale.
 - Codice rifiuto EAK: 20 01 27* colori, inchiostri da stampa, adesivi e resine sintetiche, contenenti sostanze pericolose.
 - oppure codice rifiuto EAK: 08 04 09* residui di sostanze adesive e mastici, contenenti solventi di natura organica o altre sostanze pericolose.

Contenuto: 1400 ml / 47.3 fl.oz

Peso: 1980 g / 69.8 oz

Garanzia: per informazioni sulla garanzia fare riferimento alle condizioni generali di vendita Hilti.

La mancata osservanza delle presenti istruzioni di montaggio, l'utilizzo di ancoraggi di altri produttori, condizioni del calcestruzzo magre o discutibili o applicazioni speciali possono compromettere l'affidabilità o le prestazioni dei bloccaggi.

Informazioni relative al prodotto

- Conservare le presenti Istruzioni per l'uso sempre unitamente al prodotto.
- Se affidato a terzi, il prodotto dev'essere sempre provvisto delle relative Istruzioni per l'uso.
- **Scheda tecnica dati di sicurezza:** prima di procedere con la lavorazione osservare le indicazioni riportate nella scheda tecnica dati di sicurezza.
- **Data di scadenza:** controllare la data di scadenza (mese/anno) riportata sulla giunzione della confezione. Una volta trascorsa la data di scadenza, il prodotto non deve più essere utilizzato.
- **Temperatura della confezione durante l'utilizzo:** da +5 °C a 40 °C / da 41 °F a 104 °F.
- **Condizioni di trasporto e magazzinaggio:** conservare in luogo fresco, asciutto e buio, ad una temperatura compresa tra +5 °C e 25 °C / tra 41 °F e 77 °F.
- In caso di applicazioni che non sono descritte nelle presenti Istruzioni per l'uso o che esulino dalle specifiche previste, rivolgersi a Hilti.
- **Le cartucce parzialmente utilizzate devono essere riutilizzate entro quattro settimane.** A tale scopo, lasciare la cartuccia con il miscelatore avvitato nell'applicatore ad iniezione e non far diminuire la pressione. Scollegare l'attrezzo dall'alimentazione di pressione e immagazzinarlo secondo le prescrizioni. Prima del riutilizzo, avvitare un nuovo miscelatore e scartare nuovamente la prima resina pompata..

AVVERTENZA



⚠ In caso di utilizzo non conforme, è possibile che la resina venga spruzzata fuori. Il contatto della resina con gli occhi può causare danni permanenti.

- Durante l'utilizzo del prodotto indossare appositi occhiali protettivi aderenti, guanti protettivi ed abbigliamento da lavoro!
- Non iniziare mai a pompare il prodotto se il miscelatore non è avvitato!
- Utilizzando un tubo flessibile di prolunga: lo scarto della prima resina pompata deve essere effettuato solo tramite il miscelatore in dotazione (non tramite il tubo flessibile di prolunga).
- Prima di utilizzare una nuova cartuccia avvitare un nuovo miscelatore. Accertarsi che il miscelatore sia inserito saldamente.
- Prudenza! Non svitare mai il miscelatore quando il sistema è sotto pressione.
- Utilizzare esclusivamente il tipo di miscelatore fornito con la resina. Non modificare in alcun caso il miscelatore.
- Controllare che la cartuccia e il caricatore non siano danneggiati, in particolar modo dopo la caduta! Le cartucce cadute, anche se già inserite nel caricatore, possono causare un malfunzionamento.
- Non utilizzare mai cartucce danneggiate e/o caricatori danneggiati o imbrattati.

⚠ Valori di tenuta negativi/cedimento del fissaggio a causa di un'insufficiente pulizia del foro. Prima di iniettare il prodotto, i fori devono essere asciutti e liberi da residui di foratura, polvere, acqua, ghiaccio, olio, grasso o altre impurità.

- Le punte per perforatori Hilti TE-CD, TE-YD devono essere utilizzate in combinazione con un aspiratore Hilti correttamente mantenuto, con modello e capacità di aspirazione (portata volumetrica) come specificato nella tabella degli accessori.
- Soffiaggio del foro – soffiare il foro con aria senza olio, finché l'aria che fuoriesce non risulti priva di polvere.
- Lavaggio del foro – lavare con un tubo flessibile per l'acqua con pressione normale, finché l'acqua che fuoriesce non risulti pulita.
- Importante! Prima di iniettare la resina, rimuovere l'acqua dal foro e soffiare con aria compressa priva di olio, finché il foro non risulti completamente asciutto (non applicabile su un foro eseguito con martello pneumatico in applicazioni sott'acqua).

⚠ Accertarsi che il riempimento del foro avvenga partendo dal fondo del foro stesso, affinché non vengano a crearsi bolle d'aria.

- Se necessario, utilizzare a tale scopo le apposite prolunghie per poter raggiungere il fondo del foro.
- In caso di applicazioni sopra testa, utilizzare l'accessorio HIT-SZ/IP e adattarlo soprattutto durante l'introduzione dell'elemento di fissaggio. È possibile che la resina in eccesso fuoriesca dal foro. Accertarsi che la resina non coli sull'utilizzatore.
- Se viene avvitato un nuovo miscelatore su una cartuccia già aperta, le prime pompate devono essere scartate.

⚠ La mancata osservanza delle Istruzioni d'uso può comportare il cedimento dell'ancoraggio!

Resina de inyección para la fijación de anclajes y tacos en hormigón

- ▶ Lea estas instrucciones de uso y observe las indicaciones de seguridad antes de utilizar el producto.
- ▶ Consulte con las Hoja de datos de seguridad para este producto.

Hilti HIT-RE 500 V3

Contiene: producto de reacción: 2,2-Bis[4-(4-hidroxifenil)propano bis(2,3-epoxipropil)éter (A); Trimethylolpropane triglycidylether (A); 2-methyl-1,5-pentanediamine (B); 1,3-Bencenodimetanamina (B);



Peligro

- H314 Provoca quemaduras graves en la piel y lesiones oculares graves.(A,B)
H317 Puede provocar una reacción alérgica en la piel.(A,B)
H335 Peut irriter les voies respiratoires (B)
H341 Se sospecha que provoca defectos genéticos. (A)
H360 Puede perjudicar la fertilidad o dañar al feto (A)
H411 Tóxico para los organismos acuáticos, con efectos nocivos duraderos.(A,B)

P280 Llevar guantes/prendas/gafas/máscara de protección.

P262 Evitar el contacto con los ojos, la piel o la ropa.

P302+P352 EN CASO DE CONTACTO CON LA PIEL: Lavar con agua y jabón abundantes

P305+P351+P338 EN CASO DE CONTACTO CON LOS OJOS: Aclarar cuidadosamente con agua durante varios minutos. Quitar las lentes de contacto, si lleva y resulta fácil. Seguir aclarando.

P333+P313 En caso de irritación o erupción cutánea: Consultar a un médico.

P337+P313 Si persiste la irritación ocular: Consultar a un médico.

Equipo de protección recomendado:

Protección de ojos: gafas de protección herméticas p. ej. gafas de seguridad PP EY-CA NCH claras, código #02065449; gafas protectoras PP EY-HA R HC/AF claras, código #02065591.

Protección de manos: EN 374; material de los guantes: caucho nitrílico (NBR). Tome las medidas oportunas para evitar el contacto directo con la sustancia química/el producto/el preparado.

El usuario es el responsable final de la elección de un equipo de protección apropiado.

Indicaciones de reciclaje

Cartuchos vacíos:

- ▶ Deseche el mezclador enroscado a través los sistemas de recogida nacionales identificados con el Punto Verde
 - o el código de residuo LER: 15 01 02 embalajes de plastic.



Cartuchos llenos o parcialmente vacíos:

- ▶ Deberán eliminarse como residuos especiales de acuerdo con las normativas oficiales.
 - Código de residuo LER: 20 01 27* Pinturas, tintas, adhesivos y resinas que contienen sustancias peligrosas.
 - o el código de residuo LER: 08 04 09* Residuos de adhesivos y sellantes que contienen disolventes orgánicos u otras sustancias peligrosas.

Contenido: 1400 ml / 47.3 fl.oz

Peso: 1980 g / 69.8 oz

Garantía Para información sobre la garantía, consultar las condiciones de venta estándar de Hilti.

La inobservancia de las instrucciones de instalación, el uso de anclajes que no sean Hilti, malas o dudosas condiciones del hormigón y/o aplicaciones inadecuadas pueden afectar la fiabilidad y respuesta de las fijaciones.

Información de producto

- Guarde siempre estas instrucciones de uso junto con el producto.
- En caso de entregar el producto a terceros, deben incluirse siempre las instrucciones de uso.
- **Hoja de datos de seguridad:** consulte la hoja de datos de seguridad antes de utilizar el producto.
- **Fecha de caducidad:** compruebe la fecha de caducidad (mes/año) de la pieza de conexión del cartucho. El producto no debe utilizarse después de la fecha de caducidad.
- **Temperatura del cartucho durante la utilización:** de +5 °C a 40 °C / de 41 °F a 104 °F.
- **Condiciones de transporte y almacenamiento:** lugar fresco, seco y oscuro con una temperatura de +5 °C a 25 °C / de 41 °F a 77 °F.
- Para aplicaciones que no se describen en las presentes instrucciones de uso o no se enmarcan en la especificación, póngase en contacto con Hilti.
- **Los cartuchos que no estén completamente vacíos deberán utilizarse antes de cuatro semanas.** En este caso, deje el cartucho con el mezclador enroscado en el aplicador neumático sin extraer el émbolo de presión. Desacople la herramienta del suministro de presión y guárdela conforme a las instrucciones. Antes de utilizarlo de nuevo, enroscar un nuevo mezclador y desechar la resina inicial.

ES

ADVERTENCIA



▲ La resina puede salpicar si se utiliza incorrectamente. El contacto de la resina con los ojos puede causar daños oculares permanentes.

- Lleve gafas protectoras herméticas, guantes de protección y ropa de trabajo durante el trabajo.
- No comience a exprimir si no se ha enroscado el mezclador.
- Cuando utilice la manguera de extensión: El descarte inicial de la resina se debe hacer a través del mezclador suministrado (y no a través de la manguera de extensión).
- Enrosque un mezclador nuevo antes de exprimir un cartucho nuevo. Asegúrese de que el asiento sea firme.
- ¡Precaución! No desatornille nunca el mezclador cuando el sistema se encuentre bajo presión.
- Utilice exclusivamente el modelo de mezclador suministrado con la resina. No modifique el mezclador en ningún caso.
- Compruebe si el cartucho y el portacartuchos están en perfecto estado, en particular después de una caída. Si un cartucho se cae, aun cuando se encuentre dentro del portacartuchos, es posible que no funcione correctamente.
- No utilice cartuchos en mal estado ni portacartuchos dañados o sucios.

▲ Valores de sujeción deficientes/fallo de la fijación debido a limpieza insuficiente del taladro. Antes de inyectar la resina, los taladros deben estar secos y libres de restos de perforación, polvo, agua, hielo, aceite, grasa o cualquier otro agente contaminante.

- Las brocas huecas TE-CD, TE-YD de Hilti deben utilizarse con una aspiradora de Hilti en buen estado de funcionamiento del modelo y la capacidad de succión (tasa de flujo volumétrico) que se especifican en la tabla de accesorios.
- Soplado a presión del taladro: limpie el taladro con aire a presión sin aceite hasta que el aire de retorno esté libre de polvo.
- Lavado del taladro: lave con una manguera de agua con la presión normal de la red hasta que salga agua limpia.
- ¡Atención! Antes de añadir la resina es necesario extraer el agua del taladro y limpiar el taladro con aire a presión sin aceite hasta que quede completamente seco (no aplica para agujeros realizados con taladros de percusión en aplicaciones sumergidas en agua).

▲ Verificar que el relleno del taladro se produce desde el fondo del taladro para que no se formen burbujas de aire.

- Si es necesario, utilice las prolongaciones para alcanzar el fondo del taladro.
- En aplicaciones por encima de la cabeza, utilice el accesorio HIT-SZ/IP y preste especial atención al introducir el elemento de fijación. Puede salir resina sobrante del taladro. Asegúrese de que la resina no gotee sobre el usuario.
- Si se enrosca un nuevo mezclador en un cartucho ya abierto, las primeras aplicaciones deben también desecharse.

▲ El incumplimiento de estas instrucciones puede llevar a una fijación incorrecta.

Sistema de ancoragem química para a fixação de ferros de armadura e ancoragens em betão

- ▶ Antes de utilizar este produto, siga as instruções de utilização e as precauções de segurança obrigatórias por lei.
- ▶ Consulte a Ficha de Informação de Segurança de Produtos Químicos para este produto.

Hiti HIT-RE 500 V3

Contém: produto de reacção: 2,2-Bis(4-hidroxiifenil)propano bis(2,3-epoxipropil) éter (A); Trimethylolpropane triglycidylether (A); 2-methyl-1,5-pentanediamine (B); 1,3-Benzenodimetanamina (B);



(A,B)



(A,B)



(A)



(A)



Perigo

- H314 Provoca queimaduras na pele e lesões oculares graves.(A,B)
H317 Pode provocar uma reacção alérgica cutânea.(A,B)
H335 Pode provocar irritação das vias respiratórias (B)
H341 Suspeito de provocar anomalias genéticas. (A)
H360 Pode afectar a fertilidade ou o nascituro (A)
H411 Tóxico para os organismos aquáticos com efeitos duradouros.(A,B)

P280 Usar luvas de protecção/vestuário de protecção/protecção ocular/protecção facial.

P262 Não pode entrar em contacto com os olhos, a pele ou a roupa.

P302+P352 SE ENTRAR EM CONTACTO COM A PELE: lavar com sabonete e água abundantes.

P305+P351+P338 SE ENTRAR EM CONTACTO COM OS OLHOS: enxaguar cuidadosamente com água durante vários minutos. Se usar lentes de contacto, retire-as, se tal lhe for possível. Continuar a enxaguar.

P333+P313 Em caso de irritação ou erupção cutânea: consulte um médico.

P337+P313 Caso a irritação ocular persista: consulte um médico.

Equipamento de protecção recomendado:

Protecção dos olhos: óculos de protecção por ex.: #02065449 Óculos de segurança PP EY-CA NCH claro; #02065591 Goggles PP EY-HA R HC/AF claro;

Protecção das mãos: EN 374 ; Deve-se evitar o contacto directo com o químico / o produto / o preparado através de medidas organizadas.

A escolha final dos equipamentos de protecção apropriados é da responsabilidade do utilizador

Nota sobre reciclagem

Cartuchos vazios

- ▶ Deixar o misturador enroscado e remover através dos sistemas de recolha nacionais, Ponto Verde – ou Código CER: 150102 Embalagens de plastic.



Cartuchos semiusados/novos:

- ▶ Remover de acordo com as normas e regulamentações legais sobre resíduos especiais.
 - Código CER: 20 01 27* Tintas, produtos adesivos, colas e resinas, contendo substâncias perigosas.
 - ou Código CER: 08 04 09* Resíduos de colas ou vedantes, contendo solventes orgânicos ou outras substâncias perigosas.

Conteúdo: 1400 ml / 47.3 fl.oz

Peso: 1980 g / 69.8 oz

Garantia: Para informações sobre a garantia, consulte os termos e condições de venda padrão da Hilti.

O não cumprimento destas instruções de colocação, a utilização de ancoragens que não sejam da Hilti, as condições fracas ou duvidosas do betão, ou aplicações fora do comum podem afectar a segurança ou a eficácia das fixações.

Dados informativos sobre o produto

- Guarde estas instruções de utilização sempre em conjunto com o produto.
- Entregue o produto a outras pessoas apenas juntamente com as instruções de utilização.
- **Ficha de Informação de Segurança de Produtos Químicos:** antes de iniciar os trabalhos, tenha em consideração a Ficha de Informação de Segurança de Produtos Químicos*
- **Prazo de validade:** veja o prazo de validade (mês/ano) na peça de junção do cartucho. Não utilize produtos cujo prazo de validade se encontre ultrapassado.
- **Temperatura do cartucho durante a utilização:** entre +5 °C e 40 °C / 41 °F e 104 °F.
- **Condições de transporte e armazenamento:** em lugar fresco, seco e ao abrigo da luz, entre +5 °C e 25 °C / 41 °F e 77 °F.
- Em caso de aplicações que não se encontrem descritas nas presentes instruções de utilização ou estejam fora das especificações, é favor dirigir-se à Hilti.
- **As sobras de cartuchos parcialmente usados devem ser utilizadas num prazo de quatro semanas.** Para o efeito, deixar o cartucho, com misturador enroscado, no dispensador e não reduzir a pressão. Desligar a alimentação de pressão e armazená-lo de acordo com as instruções. Antes da reutilização, enrosque um misturador novo e não utilize novamente a resina inicial.

pt

AVISO



⚠ No caso de manuseamento incorrecto, é possível que seja injectada resina. O contacto da resina com os olhos pode provocar lesões oculares permanentes!

- Durante a realização de trabalhos, use óculos de protecção que fiquem bem justos, luvas de protecção e roupa de trabalho!
- Nunca comece a aplicação sem que o misturador esteja enroscado!
- Quando utilizar a mangueira de extensão: O descarte inicial de resina deve ser feito através do misturador fornecido (e não através da mangueira de extensão).
- Antes da aplicação de um novo cartucho, enrosque um misturador novo. Certifique-se de que está bem apertado.
- Cuidado! Nunca desenrosque o misturador quando o sistema está sob pressão.
- Utilize apenas o tipo de misturador fornecido com a resina. Não modifique o misturador de forma alguma.
- Comprovar se o cartucho e o suporte não estão danificados – em particular depois de terem caído ao chão! Cartuchos que tenham caído ao chão, mesmo depois de já estarem inseridos no respectivo suporte, podem causar anomalias.
- Nunca utilize cartuchos danificados e/ou suportes danificados ou sujos.

⚠ Valores de retenção deficientes/falha da fixação devido a limpeza insuficiente do furo. Os furos devem estar secos e livres de material de perfuração, pó, água, gelo, óleo, gordura ou outras impurezas antes de efectuar a injeção.

- A brocas de perfuração ocas Hilti TE-CD e TE-YD têm de ser usadas em conjunto com um aspirador Hilti em boas condições de funcionamento e com o modelo e capacidade de aspiração (débito volumétrico) especificados na tabela dos acessórios.
- Limpar o furo por sopro – limpe o furo por sopro com ar isento de óleo, até que o ar saia sem pó.
- Lavar o furo – lave com uma mangueira com pressão normal, até sair água limpa.
- Importante! Antes de preencher com resina, retire a água do furo e sopra com ar isento de óleo até estar totalmente seco (Não utilizável em furos subaquáticos executados com percussão).

⚠ Certifique-se de que o enchimento do furo é efectuado a partir do fundo, para que não se formem bolhas de ar.

- Se necessário, utilize os prolongadores para alcançar o fundo do furo.
- No caso de aplicações em suspensão, utilize o acessório HIT-SZIP e preste especial atenção ao inserir o elemento de fixação. Pode sair resina em excesso do furo. Certifique-se de que não pinga resina sobre o utilizador.
- Se for enroscado um misturador novo num cartucho já aberto, também não utilize o produto das primeiras bombadas.

⚠ A não observação das instruções pode conduzir à falha da fixação!

Ankermortel voor bevestiging van betonijzer en pluggen in beton

- ▶ Voor gebruik deze gebruiksaanwijzing lezen en de veiligheidsvoorschriften aanhouden.
- ▶ Het veiligheidsgegevensblad van het product in acht nemen.

Hilti HIT-RE 500 V3

Bevat: 2,2-bis(4-hydroxyfenyl)propan-bis(2,3-epoxypropyl)ether (A); Trimethylolpropane triglycidylether (A); 2-methyl-1,5-pentanediamine (B); m-Xyleen, α,α' -diamine (B);



(A,B)



(A,B)



(A)



(A)



Gevaar

H314	Veroorzaakt ernstige brandwonden en oogletsel.(A,B)
H317	Kan een allergische huidreactie veroorzaken.(A,B)
H335	Kan irritatie van de luchtwegen veroorzaken (B)
H341	Verdacht van het veroorzaken van genetische schade. (A)
H360	Kan de vruchtbaarheid of het ongeboren kind schaden (A)
H411	Giftig voor in het water levende organismen, met langdurige gevolgen.(A,B)
P280	Beschermende handschoenen/beschermende kleding/oogbescherming/gelaatsbescherming dragen.
P262	Contact met de ogen, de huid of de kleding vermijden.
P302+P352	BIJ CONTACT MET DE HUID: met veel water en zeep wassen.
P305+P351+P338	BIJ CONTACT MET DE OGEN: voorzichtig afspoelen met water gedurende een aantal minuten; contactlenzen verwijderen, indien mogelijk; blijven spoelen.
P333+P313	Bij huidirritatie of uitslag: een arts raadplegen.
P337+P313	Bij aanhoudende oogirritatie: een arts raadplegen.

Aanbevolgen veiligheidsuitrusting

Oogbescherming: Nauw aansluitende schutbril bijv.: #02065449 Veiligheidsbril PP EY-CA NCH klaar; #02065591 Beschermbril PP EY-HA R HC/AF klaar

Beschermende handschoenen: EN 374; materiaal: Nitrilbutadieenrubber, NBR

Rechtstreeks contact met chemicaliën / product / de bereiding moet door organisatorische maatregelen worden vermeden.

De definitieve selectie van geschikte kleding is in de verantwoordelijkheid van de gebruiker

Aanwijzingen voor afvalverwerking

Geleegde patronen

- ▶ De mengtuit op het patroon laten zitten en via nationale inzamelsystemen afvoeren
 - of EAK-afvalcode: 15 01 02 kunststof verpakkingen.



Volle/gedeeltelijk geleegde patronen:

- ▶ Met inachtneming van de officiële voorschriften als speciaal afval afvoeren.
 - EAK-afvalcode: 20 01 27* lakken, drukinkt, lijmen en kunstharsen, die gevaarlijke stoffen bevatten.
 - of EAK-afvalcode: 08 04 09* lijm- en kitafval, dat organische oplosmiddelen of andere gevaarlijke stoffen bevat.

Inhoud: 1400 ml / 47.3 fl.oz

Gewicht: 1980 g / 69.8 oz

Garantie: Raadpleeg de standaard voorwaarden van Hilti en de verkoopvoorwaarden voor informatie over de garantie.

Als deze montage-instructies niet worden aangehouden, als ankers van een ander merk dan Hilti worden gebruikt, bij een slechte of twijfelachtige toestand van het beton of bij een uniek gebruik kan de betrouwbaarheid of de sterkte van de verbinding negatief worden beïnvloed.

Productinformatie

- Bewaar deze handleiding altijd bij het product.
- Geef het product alleen samen met de handleiding aan andere personen door.
- **Veiligheidsgegevensblad:** Raadpleeg het veiligheidsgegevensblad voor gebruik.
- **Houdbaarheidsdatum:** De houdbaarheidsdatum (maand/jaar) op het verbindingsdeel van de patroon controleren. Het product mag na afloop niet meer worden gebruikt.
- **Temperatuur van de patroon tijdens het gebruik:** +5 °C tot 40 °C / 41 °F tot 104 °F.
- **Transport- en opslagcondities:** Koel, droog en donker bij +5 °C tot 25 °C / 41 °F tot 77 °F.
- Voor toepassingen die niet in deze handleiding zijn beschreven of die buiten de specificaties liggen, contact opnemen met Hilti.
- **Niet volledig opgebruikte foliepatronen moeten binnen vier weken worden gebruikt.** Hiervoor de folie met een opgeschroefde mengtuit in het uitdrukapparaat laten en de pluñers niet terugbewegen. Het apparaat van de druktoevoer afkoppelen en volgens de voorschriften opslaan. Bij verder gebruik een nieuwe mengtuit opschroeven en opnieuw de voorlooptmortel afvoeren.

WAARSCHUWING



⚠ Ondeskundig gebruik kan mortelspatten veroorzaken. Oogcontact met de mortel kan blijvend oogletsel veroorzaken!

- Tijdens het werk een goed sluitende veiligheidsbril, werkhandschoenen en werkkleding dragen!
- Nooit zonder aangebrachte mengtuit met het uitpersen van de mortel beginnen!
- Bij gebruik van een verlengstuk: De voorlooptmortel mag uitsluitend door de geleverde mengtuit worden geperst en weggevoerd (niet door het verlengstuk).
- Bij gebruik van een nieuwe foliepatroon een nieuwe mengtuit aanbrengen. Op een correcte montage letten.
- **Attentie!** Nooit de mengtuit verwijderen als het systeem onder druk staat.
- Uitsluitend de met de mortel geleverde mengtuit gebruiken. De mengtuit onder geen enkele omstandigheid veranderen.
- Controleren of de foliepatroon en de patroonhouder onbeschadigd zijn – vooral nadat ze gevallen zijn! Gevallen verpakking, ook wanneer deze reeds in de patroonhouder zijn aangebracht, kunnen tot storingen leiden.
- Nooit beschadigde foliepatronen en/of beschadigde of sterk vervuilde patroonhouders gebruiken.

⚠ Slechte bevestigingswaarden/talen van de bevestiging door ontoereikende reiniging van het boorgat. Voor het injecteren moeten de boorgaten droog en vrij zijn van boorafval, stof, water, ijs, olie, vet of andere verontreinigingen.

- Hilti TE-CD en TE-YD holle boren moeten worden gebruikt met een goed onderhouden Hilti-stofzuiger van het model en met het zuigvermogen (debiet) zoals omschreven in de accessoiretabel.
- Uitblazen van het boorgat – het boorgat met olievrije lucht uitblazen, tot de terugstromende lucht stofvrij is.
- Uitspoelen van het boorgat – met een waterslang en normale leidingdruk uitspoelen tot er helder water uitstroomt.
- **BELANGRIJK!** Vóór het vullen met mortel het water uit het boorgat verwijderen en het gat met olievrije perslucht uitblazen tot het volledig droog is (niet van toepassing bij hamergeboorde gaten bij onderwatertoepassingen).

⚠ Opletten dat het vullen van het boorgat vanaf het einde van het boorgat plaatsvindt, zodat er geen luchtballen ontstaan.

- Indien noodzakelijk de verlengstukken gebruiken om het einde van het boorgat te bereiken.
- Bij gebruik boven het hoofd het accessoire HIT-SZ/IP gebruiken en met name oppassen bij het invoeren van het bevestigingselement. Overtollige mortel kan uit het boorgat stromen. Opletten dat er geen mortel op de gebruiker druppelt.
- Indien een nieuwe mengtuit op een reeds geopend foliepatroon wordt geschroefd, de eerste slagen eveneens weggooiden.

⚠ Als deze aanwijzingen niet worden opgevolgd kan de bevestiging loskomen!

Χημικό αγκόριο για στερεώσεις αναμονών οπλισμού και κοχλιών αγκύρωσης σε σκυρόδεμα

- ▶ Πριν από τη χρήση, διαβάστε αυτές τις οδηγίες χρήσης και ακολουθήστε τις προδιαγραφές ασφαλείας.
- ▶ Προσέξτε το δελτίο δεδομένων ασφαλείας του προϊόντος.

HiHi HIT-RE 500 V3

Περιέχει: προϊόν αντιδράσεως: δις[4-(2,3-εποξυπροποξυ)φαινυλο]προπάνιο (A); Trimethylolpropane triglycidylether (A); 2-methyl-1,5-pentanediamine (B); 1,3-Βενζολοδιμεθαναμίνη (B);



(A,B)



(A,B)



(A)



(A)



Κίνδυνος

- H314 Προκαλεί σοβαρά δερματικά εγκαύματα και οφθαλμικές βλάβες. (A,B)
H317 Μπορεί να προκαλέσει αλλεργική δερματική αντίδραση.(A,B)
H335 Μπορεί να προκαλέσει ερεθισμό της αναπνευστικής οδού (B)
H341 Ύποπτο για πρόκληση γενετικών ελαττωμάτων. (A)
H360 Μπορεί να βλάψει τη γονιμότητα ή το έμβρυο (A)
H411 Τοξικό για τους υδρόβιους οργανισμούς, με μακροχρόνιες επιπτώσεις.(A,B)

- P280 Να φοράτε προστατευτικά γάντια/προστατευτικά ενδύματα/μέσα ατομικής προστασίας για τα μάτια/πρόσωπο.
P262 Να μην έρθει σε επαφή με τα μάτια, με το δέρμα ή με τα ρούχα.
P302+P352 ΣΕ ΠΕΡΙΠΤΩΣΗ ΕΠΑΦΗΣ ΜΕ ΤΟ ΔΕΡΜΑ: Πλύνετε με άφθονο νερό και σαπούνι.
P305+P351+P338 ΣΕ ΠΕΡΙΠΤΩΣΗ ΕΠΑΦΗΣ ΜΕ ΤΑ ΜΑΤΙΑ: Ξεπλύνετε προσεκτικά με νερό για αρκετά λεπτά. Εάν υπάρχουν φακοί επαφής, αφαιρέστε τους, εφόσον είναι εύκολο. Συνεχίστε να ξεπλένετε.
P333+P313 Εάν παρατηρηθεί ερεθισμός του δέρματος ή εμφανιστεί εξάνθημα: Συμβουλευθείτε/Επισκεφθείτε γιατρό.
P337+P313 Εάν δεν υποχωρεί ο οφθαλμικός ερεθισμός: Συμβουλευθείτε/Επισκεφθείτε γιατρό.

Προτεινόμενα μέσα ατομικής προστασίας

Προστασία για τα μάτια: Προστατευτικά γυαλιά απολύτως εφαρμοστά. π.χ.: #02065449 Γυαλιά ασφαλείας PP EY-CA NCH διαφανή, #02065591 Προστατευτικά γυαλιά PP EY-HA R HC/AF διαφανή.

Προστατευτικά γάντια: EN 734, υλικό γαντιών: ελαστικό νιτριλίου, NBR

Θα πρέπει να ληφθούν μέτρα ώστε να αποφευχθεί η άμεση επαφή με τη χημική ουσία / το προϊόν / το μίγμα.

Η τελική επιλογή του κατάλληλου μέσου ατομικής προστασίας εναπόκειται στην ευθύνη του χρήστη.

Υποδείξεις για τη διάθεση στα απορρίμματα

Άδειες αμπούλες

- ▶ Αφήστε βιολογμένο τον αναμικτή και διαθέστε τις στα απορρίμματα μέσω εθνικών συστημάτων συλλογής, Grüner Punkt,
 - ή κωδικός απορριμμάτων ΕΑΚ: 15 01 02 Συσκευασίες από πλαστικό.



Γεμάτες/μισογεμάτες αμπούλες:

- ▶ Διάθεση ως ειδικά απορρίμματα λαμβάνοντας υπόψη τις σχετικές διατάξεις.
 - Κωδικός απορριμμάτων ΕΑΚ: 20 01 27* Χρώματα, μελάνια, κόλλες και συνθετικές ρητίνες, που περιέχουν επικίνδυνες ουσίες.
 - ή κωδικός απορριμμάτων ΕΑΚ: 08 04 09* Απορρίμματα κολλητικών και στεγανοποιητικών υλικών, που περιέχουν οργανικά διαλυτικά ή άλλες επικίνδυνες ουσίες.

Περιεχόμενο: 1400 ml / 47.3 fl.oz

Βάρος: 1980 g / 69.8 oz

Εγγύηση: Πληροφορίες εγγύησης βλ. γενικοί όροι πώλησης της Hilti.

Η παράβλεψη αυτών των οδηγιών συναρμολόγησης, η μη χρήση αγκυριών της Hilti, οι κακές ή αμφίβολοι ποιότητας ιδιότητες του ακυροδέματος καθώς και οι ειδικές εφαρμογές ενδέχεται να επηρεάσουν αρνητικά την αξιοπιστία και την ισχύ των στερεώσεων.

Πληροφορίες προϊόντος

- Φυλάσσετε τις παρούσες οδηγίες χρήσης πάντα μαζί με το προϊόν.
- Δίνετε το προϊόν σε άλλους μόνο μαζί με τις οδηγίες χρήσης.
- **Δελτία δεδομένων ασφαλείας:** Πριν από την εργασία προσέξτε το δελτίο δεδομένων ασφαλείας.
- **Ημερομηνία λήξης:** Ελέγξτε την ημερομηνία λήξης (μήνας/έτος) στο τμήμα σύνδεσης της αμπούλας. Δεν επιτρέπεται η χρήση του προϊόντος μετά την ημερομηνία λήξης.
- **Θερμοκρασία αμπούλας κατά τη χρήση:** +5 °C έως 40 °C / 41 °F έως 104 °F.
- **Συνθήκες μεταφοράς και αποθήκευσης:** Σε δροσερό, στεγνό και σκοτεινό χώρο από +5 °C έως 25 °C / 41 °F έως 77 °F.
- Παρακαλούμε απευθυνθείτε στη Hilti για εφαρμογές, που δεν περιγράφονται στις παρούσες οδηγίες χρήσης ή βρίσκονται εκτός προδιαγραφών.
- **Οι αμπούλες που δεν έχουν καταναλωθεί πρέπει να χρησιμοποιηθούν ξανά εντός τεσσάρων εβδομάδων.** Αφήστε για αυτόν το σκοπό την αμπούλα με τον αναμικτή βιδωμένο πάνω στη συσκευή έγχυσης και μην μετακινείτε προς τα πίσω το έμβολο πίεσης. Αποσυνδέστε τη συσκευή από την παροχή πίεσης και αποθηκεύστε το σύμφωνο με τις προδιαγραφές. Πριν την χρησιμοποίησή τους ξανά, βιδώστε καινούργιο αναμικτή και πετάξτε ξανά το πρώτο υλικό που θα εξέλθει.

ΠΡΟΕΙΔΟΠΟΙΗΣΗ



▲ Σε περίπτωση ακατάλληλης χρήσης υπάρχει το ενδεχόμενο πτασίωματος του υλικού.

H επαφή του υλικού με τα μάτια ενδέχεται να προκαλέσει μόνιμες οφθαλμικές βλάβες!

- Φοράτε κατά την εργασία εφαρμοστά γυαλιά προστασίας, προστατευτικά γάντια και φόρμα εργασίας!
- Ποτέ μην αρχίζετε την εφαρμογή χωρίς βιδωμένο τον αναμικτή!
- Σε περίπτωση χρήσης εύκαμπτου σωλήνα προέκτασης: πετάξτε το πρώτο κονίαμα μόνο μέσω του αναμικτή που παραλάβατε (όχι μέσω του εύκαμπτου σωλήνα προέκτασης).
- Πριν από τη χρήση μιας καινούργιας αμπούλας, βιδώστε καινούργιο αναμικτή. Βεβαιωθείτε ότι εδράζει καλά.
- Προσοχή! Ποτέ μην ξεβιδώνετε τον αναμικτή, όταν το σύστημα βρίσκεται υπό πίεση.
- Χρησιμοποιείτε αποκλειστικά και μόνο τον τύπο αναμικτή που παραλάβατε μαζί με το χημικό αγκύριο. Σε καμία περίπτωση μην κάνετε τροποποιήσεις στον αναμικτή.
- Ελέγξτε εάν η αμπούλα και η κασέτα είναι άθικτες – ιδίως, εάν προηγουμένως είχαν πέσει κάτω! Εάν οι αμπούλες έχουν πέσει κάτω, ακόμη κι αν ήταν ήδη μέσα στην κασέτα, μπορεί να προκαλέσουν δυσλειτουργίες.
- Ποτέ μην χρησιμοποιείτε αμπούλες και/ή κασέτες που έχουν υποστεί ζημιά ή είναι λερωμένες.

▲ Κακές πηδές συγκράτησης/αποτυχία της στερέωσης από ανεπαρκή καθαρισμό της οπής διάτρησης. Πριν από την έγχυση, πρέπει οι οπές διάτρησης να είναι στεγνές και απαλλαγμένες από υπολείμματα διάτρησης, σκόνη, νερό, πάγο, λάδι, γράσο ή άλλες ακαθαρσίες.

- Τα ειδικά τρυπάνια Hilti TE-CD και TE-YD πρέπει να χρησιμοποιούνται σε συνδυασμό με σωστά συντηρημένη ηλεκτρική σκόπια Hilti, το μοντέλο και η απορροφητική ικανότητα (παροχή όγκου) της οποίας θα είναι σύμφωνη με όσα καθορίζονται στον πίνακα των αξεσουάρ.
- Καθαρισμός οπής διάτρησης με φύσημα – φυσήξτε την οπή διάτρησης με αέρα χωρίς λάδι, μέχρι ο αέρας που επιστρέφει να μην έχει σκόνη.
- Εκκλύση της οπής διάτρησης – ξεπλύντε με λάστιχο νερού με κανονική πίεση δικτύου ύδρευσης μέχρι να εξερχεται καθαρό νερό.
- Σημαντικό! Πριν από την πλήρωση με υλικό, απομακρύνετε το νερό από την οπή διάτρησης και φυσήξτε την με πεπιεσμένο αέρα χωρίς λάδι, μέχρι να στεγνώσει τελείως (δεν αφορά οπή διανοιγμένη με κρουστικό δράπανο σε υπόγειες εφαρμογές).

▲ Βεβαιωθείτε ότι η πλήρωση της οπής διάτρησης πραγματοποιείται από τον πυθμένα της οπής, για να μη σχηματιστούν φυσαλίδες αέρα.

- Εάν χρειάζεται, χρησιμοποιήστε για αυτό το σκοπό προεκτάσεις για να φτάσετε στον πυθμένα της οπής.
- Σε εφαρμογές πάνω από το κεφάλι σας, χρησιμοποιήστε το αξεσουάρ HIT-SZ/P και προσέξτε ιδιαίτερα κατά την εισαγωγή του εξαρτήματος στερέωσης. Ενδέχεται να εξέλθει πλεονάζον υλικό από την οπή διάτρησης. Φροντίστε να μην στάξει υλικό πάνω σας.
- Εάν βιδώσετε καινούργιο αναμικτή σε ήδη ανοιχτή αμπούλα, πετάξτε επίσης τις πρώτες δόσεις.

▲ Εάν παραβλέψετε τις οδηγίες μπορεί να αποτύχει η στερέωση!

Beton demiri ve dübellerin beton içerisinde sabitlenmesi için bağlantı harcı

- Kullanımdan önce, bu kullanım kılavuzunu okuyunuz ve güvenlik yönetmeliklerine uyunuz.
- Ürünlerin güvenliğini veri formlarına bakınız.

Hiti HIT-RE 500 V3

İçerdiği maddeler: reaksiyon ürünü: 2,2'-[(1-metiletilidin)bis(4,1-fenilenokzimetilen)]bisokziran (A); Trimethylolpropane triglycidylether (A); 2-methyl-1,5-pentanediamine (B); m-Xylylenediamine (B);



(A,B)



(A,B)



(A)



(A)



Tehlike

H314	Ciddi cilt yanıklarına ve göz hasarına yol açar. (A,B)
H317	Alerjik cilt reaksiyonlarına yol açar.(A,B)
H335	Μπορεί να προκαλέσει ερεθισμό της αναπνευστικής οδού (B)
H341	Genetik hasara yol açma şüphesi var. (A)
H360	Doğmamış çocukta hasara yol açabilir veya üremeye zarar verebilir (A)
H411	Sucul ortamda uzun süre kalıcı, toksik etki.(A,B)
P280	Koruyucu eldiven/koruyucu kıyafet/göz koruyucu/üzü koruyucu kullanın.
P262	Gözle, ciltle veya kıyafetle temas ettirmeyin.
P302+P352	DERİ İLE TEMAS HALİNDE İSE: Bol sabun ve su ile yıkayın.
P305+P351+P338	GÖZ İLE TEMASI HALİNDE: Su ile birkaç dakika dikkatlice durulayın. Takılı ve yapması kolaysa, kontak lensleri çıkartın. Durulamaya devam edin.
P333+P313	Ciltte tahriş veya kaşıntı söz konusu ise: Tıbbi yardım/müdahale alın.
P337+P313	Göz tahrişi kalıcı ise: Tıbbi yardım/bakım alın.

Koruyucu donanım önerisi

Göz koruması: Kenarları sıkı kapanan koruyucu gözlük örneğin: #02065449 koruyucu gözlük PP EY-CA NCH şeffaf; #02065591 koruyucu gözlük PP EY-HA R HC/AF şeffaf;

Koruyucu eldivenler: EN 374; Eldivenlerin malzemesi: Nitril kauçuk, NBR

Kimyasal maddeler/ürünler/hazırlanmış malzeme ile doğrudan temas, organizasyon önlemleri alınarak engellenmelidir.

Uygun koruyucu donanımın nihai seçim sorumluluğu kullanıcıya aittir.

İmha Bilgileri

Boşaltılmış bidonlar

- Karıştırıcıyı çözünüz ve yerel Geri Dönüşüm toplama sistemleri aracılığıyla imha ediniz
– veya AAK atık kodu: 15 01 02 plastik ambalajlar.



Dolu/kısmen boşaltılmış bidonlar:

- Resmi makamların talimatları dikkate alınmak suretiyle özel atık olarak imha edilmelidir.
– AAK-Atık kodu: 20 01 27* tehlikeli maddeler içeren boyalar, baskı boyaaları, yapıştırıcı maddeler ve sentetik reçineler.
– veya AAK atık kodu: 08 04 09* Organik çözücüler veya diğer tehlikeli maddeleri içeren yapıştırıcı madde atıkları ve katı madde atıkları.

Miktar: 1400 ml / 47.3 fl.oz

Ağırlık: 1980 g / 69.8 oz

Garanti: Garanti bilgileri için Hilti'nin satışla ilgili standart kayıt ve şartlarına bakınız.

Bu montaj talimatlarının incelenmemesi, Hilti dışındaki tespit elemanlarının kullanılması, zayıf veya sorunlu beton koşulları sabitleme elemanlarının güvenliğini ve performansını etkileyebilir.

Ürün bilgileri

- Bu kullanma talimatını daima ürünle birlikte muhafaza ediniz.
- Ürünü, başka şahıslara ancak kullanma talimatıyla birlikte veriniz.
- **Güvenlik Bilgi Formu:** Kullanmadan önce Güvenlik Bilgi Formunu inceleyiniz.
- **Son kullanma tarihi:** Bidonun bağlantı parçası üzerindeki son kullanma tarihinin (Ay/Yıl) kontrol ediniz. Ürün, bu tarihten sonra artık kullanılamaz.
- **Kullanma esnasında bidonun sıcaklığı:** +5 °C – 40 °C / 41 °F – 104 °F.
- **Nakliye ve depolama şartları:** Serin, kuru ve karanlık yerde +5 °C – 25 °C / 41 °F – 77 °F arasında muhafaza ediniz.
- Ürünümüzü, elinizdeki bu kullanma talimatında anlatılmayan veya ürün niteliklerinin dışında kalan yerlerde uygulayacaksanız bu durumda lütfen Hilti'ye müracaat ediniz.
- **Tamamen kullanılmamış folyo tüpler dört hafta içerisinde kullanılmak zorundadır.** Bunun için bidon, vidalanmış karıştırıcı ile birlikte dışarı presleme cihazında serbest bırakılmalı ve basınç geri çekilmemelidir. Cihaz basınç beslemesinden ayrılmalı ve talimatlara uygun bir şekilde depolanmalıdır. Tekrar kullanım öncesinde yeni bir karıştırıcı takılmalı ve yeniden önceki harç boşaltılmalıdır..

⚠ UYARI



⚠ Usulüne uygun kullanılmaması halinde harç fışkırabilir. Harcin gözle temas etmesi kalıcı göz hasarlarına neden olabilir!

- Çalışma esnasında gözünüzü sıkıca kapatan bir koruyucu gözlük, koruyucu eldiven takınız ve iş elbisesi giyiniz!
- Karıştırıcı takmadan kesinlikle sıkmaya başlamayınız!
- Uzatma hortumu kullanılması: Mevcut harcin tahliyesi yalnızca belirtilen karıştırıcı ile yapılmalıdır (uzatma hortumlarıyla değil)
- Yeni bir folyo tüpü sıkmaya başlamadan önce yeni bir karıştırıcı takınız. Sabit durmasına dikkat ediniz.
- Dikkat! Sistem basınç altındayken kesinlikle karıştırıcıyı sökmeyiniz.
- Sadece harç ile birlikte gönderilen karıştırıcı tipini kullanınız. Karıştırıcıyı hiçbir durumda değiştirmeyiniz.
- Folyo tüpün ve kasetin hasarsız olma durumları kontrol edilmelidir – özellikle bunlar aşağı düştükten sonra! Önceden kaset içine yerleştirilmiş olmalarına rağmen, aşağı düşen tüpler, hatalı fonksiyonlara neden olabilir.
- Kesinlikle hasarlı folyo tüp ve/veya hasarlı veya kirli kaset kullanılmamalıdır.

⚠ Deliklerin yeterince temizlenmesi tutma değerlerinin kötü olmasına/bağlantının tutmamasına yol açar. Enjekte etmeden önce deliklerin kuru ve delme atıklarından, tozdan, sudan, buzdan, yağdan, gres yağından veya diğer kirlere arındırılması gerekir.

- Hilti TE-CD, TE-YD tozsuz delme uçları, aksesuar tablosunda belirtilen model ve emme kapasitesindeki (hacimsel debi), bakımı uygun şekilde yapılan bir Hilti elektrik süpürgeyle birlikte kullanılmalıdır.
- Deliğe hava tutma – Geri dönen havada toz kalmayınca kadar deliğe içinde yağ bulunmayan hava tutunuz.
- Deliğe su tutma – Duru su gelinceye kadar deliğe su hortumu ile normal şebeke basıncında su tutunuz.
- Önemli! Harç doldurmadan önce delikteki suyu temizleyiniz ve tam olarak kuruyana kadar yağ içermeyen basınçlı hava tutunuz (Su altındaki uygulamalarda kırıcı – delici ile açılan deliklere uygulanmaz).

⚠ Hava boşluğu oluşmaması için deliği doldurma işleminin, delik tabanından başladığından emin olunuz.

- Delik tabanına ulaşmak için gerekirse uzatmaları kullanınız.
- Baş hizasından üzerindeki uygulamalar sırasında HIT-SZ/IP aksesuarını kullanınız ve sabitleme elemanlarını yerleştirirken dikkat ediniz. Fazla harç delikten taşabilir. Uygulayıcının üzerine harç damlamadığından emin olunuz.
- Önceden açılmış folyo tüpe yeni bir karıştırıcı monte edilirse, ilk strok değerlerini göz ardı ediniz.

⚠ Talimatlara uyulmaması, sabitlemenin bozulmasına neden olabilir!

コンクリート用接着系注入方式アンカー

- ▶ ご使用になる前に本取扱説明書をお読みになり、「安全上のご注意」の記載事項を遵守してください。
- ▶ 製品の安全データシートに注意してください。

Hiti HIT-RE 500 V3

含まれています: 2-ビス [4- (オキシラン-2-イルメトキシ) フェニル] プロパン (A); 2-エチル-2- (ヒドロキシメチル) -1, 3-プロパンジオール・(クロロメチル) オキシラン重縮合物 (A); 2-メチル-1, 5-ペンタンジアミン (B); メタキシリレンジアミン (B);



(A,B)



(A,B)



(A)



(A)



危険

- H314 重篤な皮膚の薬傷及び眼の損傷 (A,B)
 H317 アレルギー性皮膚反応を起こすおそれ (A,B)
 H335 呼吸器への刺激のおそれ (B)
 H341 遺伝性疾患のおそれの疑い (A)
 H360 生殖能又は胎児への悪影響のおそれ (A)
 H411 長期継続的影響によって水生生物に毒性 (A,B)

P280 保護眼鏡, 保護服, 適切な保護手袋を着用すること。

P262 眼、皮膚、衣類につけないこと。

P305+P351+P338 眼に入った場合: 水で数分間注意深く洗うこと。次にコンタクトレンズを着用していて容易に外せる場合は外すこと。その後も洗浄を続けること。

P333+P313 皮膚刺激または発しん(疹)が生じた場合: 医師の診断 / 手当てを受けること。

P337+P313 眼の刺激が続く場合: 医師の診断 / 手当てを受けること。

P302+P352 皮膚に付着した場合: 多量の水と石けん(鹸)で洗うこと。

推奨個人保護用具:

アイシールド: 顔に密着する保護メガネ #02065449 安全メガネ PP EY-CA NCH クリア、

#2065591 保護メガネ PP EY-HA R HC/AF クリアなど

保護手袋: EN 374、手袋の材質: ニトリルゴム (NBR)

適切な対策を講じて、化学物質 / 製品 / 調剤との直接の接触を避けるようにしてください。

使用者の責任において適切な保護用具を最終的に決定してください。

廃棄に関する注意事項

使い切ったフォイルパック:

- ▶ ミキシングノズルを装着したままの状態、廃棄物回収システムグリーンポイント
 - または EAK 廃棄物コード: 15 01 02 プラスチック製パックにより処理します。



未使用あるいは使い切っていないフォイルパック:

- ▶ 所轄官庁の規定に従って特殊廃棄物として処理してください。
 - EAK 廃棄物コード: 20 01 27* 危険物質を含有した塗料、印刷インキ、接着剤および樹脂。
 - または EAK 廃棄物コード: 08 04 09* 有機系溶剤あるいはその他の危険物質を含有した接着剤およびシール剤廃棄物。

内容量: 1400 ml / 47.3 fl.oz

重量: 1980 g / 69.8 oz

保証：保証に関する情報は、ヒルティの一般販売条件をご確認ください。

本取付け説明書の記載 / 指示事項の無視、ヒルティ以外のアンカーの使用、コンクリートの性質が好ましくないあるいは信頼のおけないものであること、および特殊な使用方法は、ファスニングの信頼性と性能に影響を与える可能性があります。

製品情報

- この取扱説明書は、常に製品といっしょに保管してください。
- 製品を他者に渡す場合は、取扱説明書もいっしょに渡してください。
- 安全データシート：作業を開始する前に安全データシートをお読みください。
- 有効期限：フォイルバックの接続部に記載されている有効期限（月 / 年）を確認してください。有効期限が経過した製品は使用してはなりません。
- 使用時のフォイルバック温度：+5°C...40°C / 41°F...104°F。
- 搬送および保管条件：+5°C...25°C / 41°F...77°Fの乾燥した冷暗所にて保管してください。
- お手元の取扱説明書に記載されていない用途または製品仕様の範囲外の用途については、ヒルティにお問い合わせください。
- 使いかけのフォイルバックは、4週間以内に再使用してください。ミキシングノズルを装着したままにしておき、フォイルバックは規定に従って保管してください。再使用の際は新しいミキシングノズルを取り付け、最初に吐出する樹脂は捨ててください。

ja

▲ 警告



▲ 取扱いを誤ると、樹脂噴出の危険があります。

樹脂が眼に触れて眼に障害が残ることがあります！

- 作業時には、顔に密着した保護メガネ、保護シールドおよび作業着を着用してください！
- ミキシングノズルを正しく取り付けしていない状態で樹脂の吐出を行わないでください！
- 延長ホース使用時：最初に吐出する樹脂を捨てるには、延長ホースではなく必ずいっしょに供給されたミキシングノズルを使用してください。
- 新しいフォイルバックの樹脂を吐出する前に新しいミキシングノズルを取り付けてください。確実な取付けを確認してください。
- 注意！決してシステムに圧力がかった状態でミキシングノズルを取り外さないでください。
- 必ず樹脂といっしょに供給されたミキシングノズルタイプを使用してください。ミキシングノズルは決して改造しないでください。
- 必ず樹脂といっしょに供給されたミキシングノズルタイプを使用してください。ミキシングノズルは決して改造しないでください。
- 損傷したフォイルバック、および / あるいは損傷、汚れの激しいフォイルバックホルダーは絶対に使用しないでください。

▲ 孔内清掃が不十分だと、固定強度が低くなったり固定が不可能になります。樹脂の注入の前に、穿孔穴を乾燥させてノロ、切粉、水、オイル、グリスその他の汚れを除去する必要があります。

- Hilti 中空ドリルビット TE-CD、TE-YD は、適切にメンテナンスされ、アクセサリ表に指定されたモデルと吸引容量（容積流量）を備えた、ヒルティバキュームクリーナーとともに使用してください。
- 孔のプロア-還流エアに切粉がなくなるまで、油分を含まないエアで孔をブローします。
- 孔の洗浄-透明な水が流出するまで、ウォーターホースにより通常の水道水圧で洗浄します。
- 重要！樹脂を注入する前に穿孔穴から水分を除去し、穿孔穴が完全に乾くまでオイルを含まない圧縮エアでブローします（この方法は、水中の打撃穿孔穴に対しては行わないでください）。

▲ エアポケットが発生しないよう、樹脂は必ず穿孔穴の底部から注入してください。

- 必要に応じて延長ノズルを使用して樹脂が穿孔穴の底部に届くようにしてください。
- 頭上作業の際はアクセサリ HIT-SZIP を使用し、ファスナーの挿入時には特に注意してください。樹脂が多すぎると穿孔穴からあふれ出ることがあります。樹脂があふれて滴り落ちていないことを確認してください。
- 新しいミキシングノズルを開封済みのフォイルバックに取り付けた場合も、最初に吐出する樹脂を捨てる必要があります。

▲ 指示を無視すると、ファスニングに失敗することがあります。

用于在混凝土中固定钢筋和锚的胶粘剂锚固系统

- ▶ 在使用产品之前, 应遵守使用说明和法律规定的安全预防措施。
- ▶ 详细信息请参阅化学品安全技术说明书

嵌缝剂 HIT-RE 500 V3

Injectable mortar HIT-RE 500 V3

组份A: 2,2'-[(1-甲基乙基)双(4,1-亚苯氧基亚甲基)]双环氧乙烷 30-40%; 苯酚与甲醛和缩水甘油醚的聚合物 10-20%; 2,2'-[1,4-丁二基二(氧亚甲基)]双环氧乙烷 5-10%; 2-乙基-2-(羟甲基)-1,3-丙二醇与氯甲基环氧乙烷的聚合物 5-10%; 2,3-环氧丙基丙基三甲氧基硅烷 2.5-5%; 组份B: 2-甲基-1,5-戊二胺 25-35%; 苯乙烯化苯酚 5-10%; 1,3-间苯二甲胺 5-8%; 2,4,6-三[(二甲氨基)甲基]苯酚 1-2.5%; 3-三乙氧基甲硅烷基-1-丙胺 1-2.5%



(A,B)



(A,B)



(A)



(A)



危险

造成严重皮肤灼伤和眼损伤 可能导致皮肤过敏反应 可能造成呼吸道刺激 可能对生育能力或胎儿造成伤害 怀疑可能造成遗传性缺陷

对水生生物有毒并具有长期持续影响

(预防措施): 戴防护眼罩、穿防护服、戴防护手套 严防进入眼中、接触皮肤或衣服

(事故响应): 如进入眼睛: 用水小心冲洗几分钟。如戴隐形眼镜并可方便地取出, 取出隐形眼镜。继续冲洗 如发生皮肤刺激或皮疹: 求医/就诊 如仍觉眼刺激: 求医/就诊 如有皮肤沾染: 使用大量水清洗

(安全储存): 防日晒。存放在通风良好处

(废弃处置): 处置内装物/容器至 依据当地、地区、国家和/或国际法规, 由危险或特殊废弃物收集中心处理

请参阅化学品安全技术说明书

供应商: 喜利得(中国)商贸有限公司 地址: 上海市浦东新区耀元路58号环球都会广场2号楼8层
电话: +86 21 6016 7316 传真: 邮编: 200126 中国境内化学事故应急咨询电话: +86-400-6267-911

推荐的防护装备:

眼睛防护: 紧密密封的安全眼镜; 例如: # 02065449 安全眼镜 PP EY-CA NCH 清晰;

02065591 护目镜 PP EY-HA R HC/AF 清晰;

防护手套: EN 374; 手套材质: 丁腈橡胶 (NBR)

通过组织措施避免直接接触化学品/产品/制剂。

最终选择适当的防护装备是用户的责任

废弃处理方法

空铝箔包:

- ▶ 请勿拆下混合嘴, 欲进行废弃处置时, 请交给当地的环保回收单位依类别回收
- 或是EAK废弃物法: 150102塑胶包装回收



全满或半满的铝箔包:

- ▶ 必须遵照国家法规作为特殊废弃物处理。

- EAK废弃物法: 20 01 27*漆、墨、胶粘剂与含危险成份的树脂。

- 或是EAK废弃物法: 08 04 09*废弃胶粘剂与含有有机溶剂或其他危险成份的密封胶。

容量: 1400 ml / 47.3 fl.oz

重量: 1980 g / 69.8 oz

保修：关于保修信息，请参见喜利得标准销售条款和条件。

未遵守这些安装说明、未使用喜利得锚固胶粘剂、混凝土状况差或在特定的应用场合都可能影响锚固的可靠性或性能。

产品信息

- 应始终将本使用说明与产品保存在一起。
- 当您产品交给他人时，请确保一并交付本使用说明。
- **材料安全数据表：**使用前应仔细察看材料安全数据表。
- **检查产品有效期：**参见锡箔包连接头上的有效期印记(月/年)。切勿使用过期产品。
- **使用期间的锡箔包温度：**在 +5 °C 至 40 °C / 41 °F 至 104 °F 之间。
- **运输和存储条件：**存放在阴凉、干燥处，避光保存，温度在 +5 °C 至 25 °C / 41 °F 至 77 °F 之间。
- 对于本文件未涉及的任何应用场合/规定范围以外的数值，请与喜利得公司联系。
- **未完全用完的锡箔包必须在四周内用完。将混合嘴保持安装在锡箔包连接头上，并存放在推荐的存储条件下。如再次使用，应连接一个新的混合嘴，并废弃刚混合的锚固胶粘剂量。**

CN

警告



- ▲ **不适当的处理，可能会导致砂浆飞溅。眼睛接触到砂浆可能会导致永久的视力损害！**
 - 在处理砂浆前，应始终穿戴严密的护目镜、手套和防护服！
 - 在混合嘴未适当旋上时，切勿开始注射。
 - 当使用加长软管时：必须只能通过附带的混合嘴(而不是通过加长软管)排出最初使用的砂浆流。
 - 在注射新的锡箔包之前，应连接新的混合嘴(两者必须完全密封)。
 - 小心：切勿在锡箔包系统处于压力之下时拆除混合嘴。按下注射器的释放按钮以避免砂浆飞溅。
 - 只能使用与粘结砂浆一起提供的混合嘴类型且只能给混合嘴供应粘结砂浆。不要以任何方式改变混合嘴。
 - 请确认铝箔包和铝箔包套筒是否功能正常或有损坏—特别是有低漏的状况时。低漏的铝箔包，包含已经装入套筒才发生低漏的铝箔包都可能造成故障。
 - 切勿使用损坏的锡箔包和/或损坏的或不清洁的锡箔包套筒。
- ▲ **钻孔清洁不够会引起锚固点负荷数值不良/潜在失效。在注入粘结砂浆之前，钻孔内必须干燥并且不得有灰尘、水、碎屑、冰、油、油脂或者其它污染物。**
 - 喜利得空心钻头TE-CD, TE-YD必须配合得到正确保养的喜利得吸尘器使用，其型号和抽取能力(体积流量)列于附表。
 - 对于钻孔吹气-用不含油的空气吹气，直至返回的气流无可见的灰尘。
 - 对于钻孔冲洗-用水管压力冲洗，直至流出来的水变得清澈。
 - **重要提示！在注入砂浆之前，将水全部从钻孔中清除并用无油压缩空气吹气，直到钻孔完全变干(适用于水下应用中的锤击钻孔)。**
- ▲ **确保从钻孔底部开始加注(避免形成气隙)。**
 - 必要时，可使用配件/加长件，以达到钻孔底部。
 - 对于垂直头顶应用场合，请使用垂直头顶配件 HIT-SZ / IP，并在插入锚固元件时要特别小心。注意过多的粘结砂浆可能会从钻孔中压出。确保没有砂浆滴到锚固装置上。
 - 如果将新的混合嘴安装在先前打开的锡箔包上，则必须废弃第一次扣动扳机时喷出的砂浆。
- ▲ **不遵守这些安装说明可能会造成固定点损坏！**

Hilti HIT-RE 500 V3 1400 Jumbo

用於混凝土中固定鋼筋及安卡的黏著安卡系統

- ▶ 使用產品前，請遵守使用操作說明，以及法律規定之安全預防措施。
- ▶ 請閱讀安全資料表。

Hilti HIT-RE 500 V3

包含 2,2'-[(1-甲基亞乙基)双(4,1-亞苯氧基亞甲基)]双环氧乙烷 (A), Trimethylolpropane triglycidylether (A); 2-甲基戊二胺 (B); 間二甲苯二胺 (B)



(A,B)



(A,B)



(A)



(A)



危險

- H314 引起嚴重的皮膚灼傷和眼睛損傷。(A,B)
H317 可能引起皮膚過敏性反應。(A,B)
H335 可能造成呼吸道刺激 (B)
H341 懷疑造成遺傳性缺陷 (A)
H360 可能對生育能力或對胎兒造成傷害 (A)
H411 對水生生物有毒並具有長期持續影響。(A,B)

P280 戴防護手套/穿防護服/戴防護眼罩/戴防護面具。

P262 嚴防進入眼中、接觸皮膚或衣服沾汙。

P305+P351+P338 如進入眼睛：用水小心沖洗幾分鐘。如戴隱型眼鏡並可方便地取出，取出隱型眼鏡。繼續沖洗。

P333+P313 如發生皮膚刺激或皮疹：求醫/就診。

P337+P313 如仍覺眼刺激：求醫/就診

P302+P352 如皮膚沾染：用大量肥皂和水清洗。

建議保護裝備：

眼睛保護： 密閉的安全眼鏡，例如編號02065449透明安全眼鏡PP EY-CA NCH；編號02065591透明護目鏡PP EY-HA R HC/AF；

防護手套： EN 374；手套材質：腈橡膠 (NBR)

採取規定措施，避免直接接觸化學物質 / 產品 / 製品。

選用適當的防護裝備為使用者之責任

廢棄處置

空鋁箔包：

- ▶ 請勿拆下混合器，欲進行廢棄處置時，請交給當地的環保回收單位依適當類別回收
- 或按照EAK廢料法 15 01 02 塑膠包裝回收。



全滿 / 半滿的鋁箔包：

- ▶ 依照政府規定進行特殊廢棄物的廢棄處置。
- EAK廢料法：20 01 27* 漆、墨、膠黏劑與含危險成份的樹脂。
- 或廢料法：EAK 08 04 09* 廢棄膠黏劑與含有機溶劑或其他危險成份的密封劑。

容量： 1400 ml / 47.3 fl.oz

重量： 1980 g / 69.8 oz

保固：保固資訊請參閱標準Hilti銷售條款與條件

未遵循安裝說明、使用非Hilti安卡、混凝土狀況不良或是有疑慮、或是特殊的應用可能會影響固定的可靠程度與效果。

產品資訊

- 請將本使用說明書與產品一同存放。
- 機具轉交給他人時，必須連同本使用說明書一起轉交。
- **檢查到期日**：參見錫箔包裝相關位置的使用期限（月份 / 年份）。請勿使用已過期的產品。
- **使用期間的錫箔藥劑包溫度**：+5 °C到40 °C / 41 °F到104 °F。
- **搬運及貯放條件**：置於陰涼、乾燥及陰暗場所，溫度保持在+5 °C到25 °C / 41 °F到77 °F之間。
- 若有任何本文件沒有包含的應用情況 / 超出指定的數值，請聯絡Hilti。
- **未用完的錫箔藥劑包需在四週內用完**。將混合器留在錫箔藥劑包歧管上並存放在建議的儲存條件下。若經過重複使用，裝上新的混合器，並捨棄安卡黏著劑的初次使用量。

警告



zh

- ▲ **錯誤處理可能會導致植筋劑噴濺。植筋劑如果接觸眼睛可能會造成無法復原的傷害！**
 - 開始處理植筋劑前，務必戴上密著式的護目鏡、手套及防護衣。
 - 混合器未緊緊鎖上前，切勿開始注射。
 - 使用延長管時：必須透過隨附的混合器去除開始使用時的植筋劑。
 - 注射新錫箔藥劑包前先安裝新的混合器（確保緊密安裝）。
 - 注意！在錫箔藥劑包仍處於壓力下時，不得拆下混合器。按下注射器上的釋放按鈕以避免植筋劑噴濺。
 - 僅能使用黏著劑隨附的混合器類型。不可修改混合器的任何地方。
 - 絕對不可使用受損的錫箔包與受損或不乾淨的錫箔藥劑包套筒。
- ▲ **孔洞未妥善清潔造成較差的負載值或是固定點可能會失效。黏著劑注射前，孔洞必須保持乾燥且沒有碎片、粉塵、水、冰、油、油脂和其他污染物。**
 - 喜利得空心鑽頭 TE-CD, TE-YD 必須配合得到正確保養的喜利得吸塵機使用，其型號和抽吸能力（體積流量）列於附表。
 - 孔洞吹風清潔 – 以無油空氣吹風，直到回風沒有可見的粉塵為止。
 - 孔洞清洗清潔 – 以加壓水沖洗，直到流出的水乾淨為止。
 - 重要資訊！注射植筋劑前必須清除孔洞中的水分，並使用無油壓縮空氣完全吹乾（不適用於水中的鏈擊鑽孔）。
- ▲ **確保孔洞由後方填滿，而沒有出現空隙。**
 - 如有需要，可使用配件 / 延長線清理孔洞後方。
 - 若使用於高處，請使用高處配件HIT-SZ / IP，並於置入固定元件時請特別小心。多餘的黏著劑可能會被擠出孔洞。請確定沒有植筋劑滴落在安裝人員身上。
 - 若要将新的混合器安裝至先前已開啟過的錫箔包上，必須丟棄第一個注射控制鈕。
- ▲ **不遵守這些安裝說明可能會造成固定點損壞！**

콘크리트 고정용 철근 및 핀 연결 모르타르 시스템

- ▶ 사용 전에 본 사용설명서를 숙독하고 안전규칙을 준수한다.
- ▶ 제품의 안전자료에 유의한다.

Hilti HIT-RE 500 V3

포함: 비스페놀 A 다이글리시딜 에테르 (A), Trimethylolpropane triglycidylether (A), m-자일렌다이아민(m-크실렌디아민) (B) 2-methyl-1,5-pentanediamine (B)



(A,B)



(A,B)



(A)

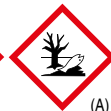

(A)



위험

- H314 피부에 심한 화상과 눈에 손상을 일으킴 (A,B)
 H317 알레르기성 피부 반응을 일으킬 수 있음 (A,B)
 H335 호흡기계 자극을 일으킬 수 있음 (B)
 H341 유전적인 결함을 일으킬 것으로 의심됨 (A)
 H360 태아 또는 생식능력에 손상을 일으킬 수 있음 (A)
 H411 장기적인 영향에 의해 수생생물에게 유독함(A,B)

P280 보호장갑·보호의·보안경·안면보호구를 착용하십시오.

P262 눈, 피부, 의복에 묻지 않도록 하시오.

P302+P352 피부에 묻으면 다량의 물과 비누로 씻으시오.

P305+P351+P338 눈에 묻으면 몇 분간 물로 조심해서 씻으시오. 가능하면 콘택트렌즈를 제거하십시오. 계속 씻으시오.

P333+P313 피부자극성 또는 홍반이 나타나면 의학적인 조치·조언을 구하십시오.

P337+P313 눈에 자극이 지속되면 의학적인 조치·조언을 구하십시오.

권장 보호장비:

눈 보호: 쪽조이는 보안경 예: #02065449 보안경 PP EY-CA NCH 클리어; #02065591 보안경 PP EY-HA R HC/AF 클리어;

보호장갑: EN 374; 장갑 소재: 니트릴 고무, NBR

조직차원의 조치를 통해 조제 시 화학물질 / 제품과의 직접적인 접촉을 피해주시길 바랍니다.

적절한 보호장비의 최종 결정은 사용자 책임입니다.

폐기 지침

빈 용기

- ▶ 믹서의 나사를 풀고 해당 국가의 수거 및 처리 방침에 따라 폐기처리
- 또는 EAK 폐기물 코드: 15 01 02 플라스틱 포장재



완전히/부분적으로 비어 있는 용기:

- ▶ 당국의 규정에 유의하여 위험폐기물로 구분하여 폐기처리한다.

- EAK 폐기물 코드: 20 01 27* 유독물질을 함유한 페인트, 인쇄용 잉크, 접착제, 합성 수지

- 또는 EAK 폐기물 코드: 08 04 09* 유기용매 또는 기타 유독물질을 함유한 접착제 및 실러 폐기물

내용물: 1400 ml / 47.3 fl.oz

무게: 1980 g / 69.8 oz

품질 보증서: 품질 보증 관련 정보는 Hilti의 일반 판매 조건을 참조.

본 설치 설명서에 유의하지 않거나 Hilti 정품이 아닌 앵커를 사용할 경우, 또는 콘크리트 상태가 불량하거나 품질이 좋지 않은 경우 및 특수한 목적으로 사용할 경우에는 고정 작업의 안전성과 효율성이 저해될 수 있다.

제품 정보

- 본 사용설명서를 항상 제품과 함께 보관한다.
- 제품을 타인에게 양도할 경우 반드시 사용설명서를 함께 전달한다.
- 안전자료: 작업 전에 안전자료에 유의한다.
- 유효기간: 용기 연결부에 있는 유효기간(월/연도)을 확인한다. 유효기간이 지난 제품을 사용해서는 안 된다.
- 사용 중 용기 온도: +5 °C ~ 40 °C / 41 °F ~ 104 °F
- 운반 및 보관 조건: 건조하며 서늘하고 어두운 곳에서 +5 °C ~ 25 °C / 41 °F ~ 77 °F 온도에 보관.
- 기존 사용설명서에서 다루지 않은 방법을 사용할 경우, Hilti에 문의한다.
- 쓰고 남은 용기는 4주 이내에 다시 사용해야 한다. 이를 위해 디스펜서에 연결된 믹서와 용기를 그대로 두고 압력 피스톤을 되당기지 않는다. 디스펜서에 압력공급을 차단하고 규정에 맞게 보관한다. 계속해서 사용 시 새로운 믹서를 볼트로 연결하고 처음 흘러나온 모르타르는 다시 폐기한다.

경고



- ▲ 취급 방법이 올바르지 않을 경우 모르타르가 분사될 수 있다. 모르타르가 눈에 닿은 경우 눈에 손상을 가져올 수 있다.
 - 작업 시에는 누설되지 않는 보안경, 보호장갑 및 작업복을 착용한다.
 - 믹서를 제대로 장착하지 않은 상태에서 절대 압착을 시작하지 않는다.
 - 연장 호스 사용 시: 처음 흘러나온 모르타르는 제공된 믹서를 통해서만 폐기한다(연장 호스를 통해서 하면 안 됨).
 - 새 용기를 압착하기 전에 새로운 믹서를 연결한다. 단단히 고정시키도록 주의한다.
 - 주의! 시스템이 압력을 받는 상태에서 믹서를 풀지 않는다.
 - 모르타르와 함께 제공된 믹서모델만을 사용한다. 어떠한 환경에도 믹서를 변형시켜서는 안 된다.
 - 포장용기와 카트리지가 손상되었는지 점검한다. - 특히 바닥에 떨어뜨린 후! 떨어뜨린 용기는 이미카트리지에 끼운 상태여도 오작동을 일으킬 수 있다.
 - 절대 손상된 포장용기 그리고/또는 손상되거나 오염된 카트리지를 사용해서는 안 된다.
- ▲ 천공구멍 세척이 충분히 이루어져 있지 않은 경우, 하중값이 부정확하고 고정이 안 될 수 있다. 모르타르 분사 전에 천공 구멍을 건조시키고, 남아 있는 부스러기, 먼지, 물기, 얼음, 오일, 그리스 또는 기타 이물질질을 제거해야 한다.
 - Hilti 중공 드릴 비트 TE-CD, TE-YD는 액세서리 테이블에 명시된 모델 및 흡입 용량(용적 용량)을 갖춘 적절히 관리된 힐티 진공 청소기와 함께 사용해야 한다.
 - 천공구멍 불어내기-천공구멍을 오일기가 없는 공기로 불어내며, 역류하는 공기에 먼지가 포함되어 있지 않을 때까지 계속 실행한다.
 - 천공구멍 세척하기-맑은 물이 흘러 나올 때까지 물 호스를 사용하여 일반 수압으로 천공구멍을 세척한다.
 - 중요! 모르타르를 채우기 전에 천공구멍에서 물을 제거하고 완전히 건조될 때까지 오일기가 없는 공기로 불어낸다(수중 사용시 해머 드릴 구멍에는 적용되지 않음).
- ▲ 기포가 생성되지 않도록 천공구멍 바닥부터 천공구멍이 채워지는지 확인한다.
 - 필요에 따라 천공구멍 바닥에 도달하기 위해 연장부를 사용한다.
 - 필장 작업 시 HIT-SZ/IP 액세서리를 사용하고 특히 고정 요소 삽입 시 주의한다. 모르타르가 과도하게 사용되면 모르타르가 천공구멍 밖으로 새어 나올 수 있다. 모르타르가 사용자에게 떨어지지 않는지 확인한다.
 - 이미 개봉된 용기에 새로운 믹서를 연결시킬 경우, 마찬가지로 방아쇠를 당겨 처음 배출되는 모르타르를 폐기한다.
- ▲ 지침에 유의하지 않을 경우 고정작업이 실패할 수 있다.

الضمان: للمعلومات حول الضمان ارجع إلى الشروط العامة للبيع الخاصة بشركة Hilti.

قد يتسبب عدم مراعاة دليل التركيب أو استخدام عناصر تثبيت غير معروفة لشركة Hilti أو العمل في خصائص خرسانة سيئة أو مشكوك فيها أو الاستخدامات الخاصة إلى التأثير بشكل سلبي على قدرة واعتمادية التثبيت.

معلومات المنتج

- احتفظ دائما بإرشادات الاستخدام هذه مع المنتج.
- ولا تقم بتسليم المنتج لأشخاص آخرين إلا مع إرفاق إرشادات الاستخدام به.
- **نشرة بيانات السلامة:** تراعى نشرة بيانات السلامة قبل الشروع في العمل.
- **تاريخ الصلاحية:** راجع تاريخ الصلاحية (الشهر/السنة) المطبوع على ثنية الوصل بالعبوة. ولا يجوز استخدام المنتج بعد انتهاء تاريخ الصلاحية.
- درجة حرارة العبوة **أثناء الاستخدام:** +٥ °م حتى ٤٠ °م / ٤١ °م حتى ١٠٤ °م.
- **شروط النقل والتخزين:** في مكان بارد وجاف ومظلم عند +٥ °م حتى ٢٥ °م / ٤١ °م حتى ٧٧ °م.
- بالنسبة للتطبيقات التي لم يتم شرحها في إرشادات الاستخدام هذه والتي تخالف المواصفات، يرجى الاتصال بشركة Hilti.
- في حالة عدم استهلاك محتويات الأنبوب بالكامل يجب استكمال استخدامها خلال أسبوع واحد. ولذلك يجب ترك الأنبوب مربوط مع الخلط في جهاز الكبس وعدم سحب الضغط. ویراعی أيضا فصل خرطوم الضغط وتخزينه طبقا للتعليمات. وقيل إعادة الاستخدام يجب ربط خلط جديد والتخلص مجددا من الكمية الأولى للخلط.



تحذير

⚠ في حالة الاستخدام غير المطابق للتعليمات قد يتطاير رذاذ من الملاط. ويمكن أن تؤدي ملامسة الملاط للعينين إلى حدوث أضرار بالعينين.

- احرص أثناء العمل على ارتداء نظارة واقية محكمة الغلق وقفاق واق لليدين وملابس مناسبة لطبيعة العمل!
- لا تشرع أبدا في عملية الحقن دون ربط الخلط.
- في حالة استخدام خرطوم تطويل: تخلص من مقدمة الملاط من خلال الخلط المورد فقط (وليس من خلال خرطوم التطويل).
- قبل تفريغ محتويات أنبوب جديد يجب ربط خلط جديد. يراعى التأكد من إحكام التثبيت.
- احترس! لا تقم أبدا بفتح الخلط إذا كان النظام واقعا تحت ضغط.
- اقتصر على استخدام نوع الخلط المورد مع الملاط. ولا تقم بإجراء تعديلات على الخلط بأي حال من الأحوال.
- لا تستخدم أبدا أنبوبا تالفا و/أو خرطوش تالفة أو متسخة.

⚠ تدني قوى التثبيت/فشل عملية التثبيت بسبب النظافة غير الكافية للثقب. قبل الحقن يجب تنظيف الثقب من أية شوائب ناتجة عن عملية الثقب أو أتربة أو ماء أو بلج أو زيوت أو شحوم أو أية استساخات أخرى.

- يجب استخدام لقم حفرة التجاويف TE-CD و TE-YD من Hilti مع شفاط هواء Hilti محفوظ بشكل صحيح بالطرز و قدرة الشفط (معدل التدفق الجمجمي) المحددة في جدول المحفقات.
- تنظيف الثقب من خلال الفنج - انفع الثقب بتيار هواء خال من الزيت إلى أن يخرج الهواء من الثقب خاليا من الأتربة.
- شطف الثقب - اشطف الثقب باستخدام خرطوم ماء والضغط المعتاد لشبكة المياه إلى أن ينساب ماء تقى من الثقب.
- هام! قبل ملء الثقب بالملاط يجب إزالة الماء من الثقب وتنظيفه من خلال النفخ بالهواء المضغوط الخالي من الزيت، إلى أن يصبح الثقب جافا تماما (لا يسري على الثقب التي يتم عملها بالمثاق المطرق في تطبيقات الاستخدام تحت الماء).

⚠ تأكد أن عملية ملء الثقب بالملاط تبدأ من قاع الثقب، كي لا تتكون فقاعات هواء بداخله.

- عند الضرورة استخدم لهذا الغرض وسائل إطالة للوصول إلى قاع الثقب.
- في حالة القيام بتطبيقات فوق مستوى الرأس استخدم الملحق التكميلي HIT-SZ/IP وتوخ الحذر الشديد عند إدخال عنصر التثبيت. فقد يخرج الملاط الفاضل من الثقب. لذا تأكد من عدم تساقط الملاط على المستخدم.
- ⚠ في حالة ربط خلط جديد على أنبوب مفتوح بالفعل، قم أيضا بالتخلص من الكمية الأولى للملاط.

يمكن ان يؤدي عدم مراعاة التعليمات إلى فشل عملية التثبيت!

ملاط التثبيت لأعمال تثبيت أسياخ الحديد والخوابير في الخرسانة

- ◀ احرص قبل الاستعمال على قراءة إرشادات الاستخدام هذه والالتزام بتعليمات الأمان.
- ◀ تراعى نشرة بيانات السلامة الخاصة بالمنتج.

Hilti HIT-RE 500 V3

2,2'-[1-methylethylidene]bis(4,1-phenyleneoxymethylene)]bisoxirane (A); Trimethylolpropane triglycidylether (A); 2-methyl-1,5-pentanediamine (B); m-Xylylenediamine (B)



(A)
خطر

(A,B)

(A,B)

(A)

H314 يسبب حروقا جلدية شديدة وتلفا للعين. (A,B)

H317 قد يسبب تفاعلا للحساسية في الجلد. (A, B)

H355 قد يسبب تهيجا تنفسيا (B)

H341 يشبه بأنه يسبب عيوباً جنينية. (A)

H360 قد يتلف الخصوبة أو الجنين (A)

H411 سمي للحياة المائية مع تأثيرات طويلة الأمد. (A,B)

P280 توضع قفازات حماية/ملايس حماية/ وقاء للعينين/للوجه.

P262 يلزم تجنب ملامسة المنتج للعين أو الجلد أو الملابس..

P302+P352 في حالة السقوط على الجلد: يغمر بوفرة من الصابون والماء.

P305+P351+P338 في حالة دخول العين: تنظف باحتراس بماء لعدة دقائق. تنزع العدسات اللاصقة إذا كان ذلك أمرا سهلا. يستمر الشطف.

P333+P313 إذا حدث تهيج أو طفح جلدي: تطلب استشارة الطبيب/الرعاية الطبية

P337+P313 إذا استمر تهيج العين: تطلب استشارة الطبيب/الرعاية الطبية.

تجهيزات الحماية الشخصية الموصى بها:

واقية للعينين: نظارة حماية محكمة الغلق، مثل #02065449 نظارة الأمان الصافية PP EY-CA NCH و #02065591 النظارة الصافية

PP EY-HA R HC/AF

قفاز واق لليدين: EN 374، خامة القفاز: مطاط النتريل، NBR

يجب تجنب التلامس المباشر مع الكيماويات/المنتج/المستحضرات عبر إجراءات تنظيمية.

الاختبار النهائي لتجهيزات الحماية المناسبة مسؤولة المستخدم.

إرشادات التخلص من النفايات

العبوة الفارغة



◀ اترك الخلاط مركبا وقم بالتخلص منها لدى مستودعات نظم التجميع المحلية، النقطة الخضراء

– أو كود المخلفات EAK: 02 15 01 02 عبوات التغليف البلاستيكية.

العبوة المملوءة أو الفارغة جزئيا:

◀ قم بالتخلص منها مع مراعاة التعليمات الرسمية باعتبارها مخلفات ذات طبيعة خاصة.

– كود المخلفات EAK: 27* 01 20 01 للألوان والألوان الطباعية والمواد اللاصقة والأصماغ الصناعية التي تحتوي على مواد خطيرة.

– أو كود المخلفات EAK: 09* 04 08 لنفايات المواد اللاصقة ومواد الإحكام التي تحتوي على مذيبات عضوية أو غيرها من

المواد الخطيرة.

المحتوى: ١٤٠٠ جرام/ ٤٧,٣ أونس سائل الوزن ١٩٨٠ جم/ ٦٩,٨ أونس

Sistem penambatan perekat untuk batang penulangan dan pengikatan penambatan dalam konkrit

- ▶ Sebelum menggunakan produk, ikuti arahan untuk penggunaan dan langkah keselamatan yang diwajibkan undang-undang.
- ▶ Lihat Risalah Data Keselamatan untuk produk ini.

Hilti HIT-RE 500 V3

Mengandungi: 2,2'-[(1-methylethylidene)bis(4,1-phenyleneoxymethylene)]bisoxirane (A); Trimethylolpropane triglycidylether (A); 2-methyl-1,5-pentanediamine (B); m-Xylylenediamine (B);



(A,B)



(A,B)



(A)



(A)



Bahaya

H314	Menyebabkan luka terbakar pada kulit dan kerosakan mata yang teruk.(A,B)
H317	Boleh menyebabkan tindak balas kulit alahan.(A,B)
H335	Boleh menyebabkan kerengsaan saluran pernafasan (B)
H341	Disyaki menyebabkan kecacatan genetik. (A)
H360	Boleh merosakkan kesuburan atau janin (A)
H411	Toksik kepada hidupan akuatik dengan kesan berpanjangan.(A,B)
P280	Pakai sarung tangan pelindung/pakaian pelindung/perlindungan mata/perlindungan muka.
P262	Jangan biarkan terkena mata, kulit atau pakaian.
P302+P352	JIKA TERKENA KULIT: Basuh dengan sabun dan air yang banyak.
P305+P351+P338	JIKA TERKENA MATA: Bilas berhati-hati dengan air selama beberapa minit. Tanggalkan kanta lekap, jika ada dan mudah berbuat demikian. Teruskan membilas.
P333+P313	Jika berlaku kerengsaan kulit atau ruam: Dapatkan nasihat/rawatan perubatan.
P337+P313	Jika kerengsaan mata berterusan: Dapatkan nasihat/rawatan perubatan.

Peralatan pelindung yang disyorkan:

Pelindung mata: Kaca mata keselamatan yang kedap cth.: #02065449 Kaca mata keselamatan PP EY-CA NCH jernih; #02065591 Gogal PP EY-HA R HC/AF jernih;

Sarung tangan pelindung: EN 374 ; Material sarung tangan: Getah nitril, NBR

Elakkan sentuhan secara langsung dengan bahan kimia/produk/penyediaan tersebut melalui langkah teratur.

Pemilihan terakhir untuk peralatan pelindung yang sesuai adalah tanggungjawab pengguna

Pertimbangan pelupusan

Bungkusan kosong

- ▶ Biarkan Pengadun dipasang dan lupuskan melalui sistem pungutan Titik Hijau tempatan
- atau kod bahan buangan EAK 15 01 02 pembungkusan plastik



Bungkusan penuh atau separuh kosong:

- ▶ lupuskan sebagai buangan khas menurut peraturan rasmi.
- Kod bahan buangan EAK: 20 01 27* cat, dakwat, perekat dan resin mengandungi bahan berbahaya.
- atau kod bahan buangan: EAK 08 04 09* perekat buangan dan pengedap yang mengandungi pelarut atau bahan berbahaya lain.

Kandungan: 1400 ml / 47.3 fl.oz

Berat: 1980 g / 69.8 oz

Waranti: Rujuk kepada terma dan syarat jualan Hilti standard untuk maklumat waranti.

Kegagalan untuk memahami arahan pemasangan, penggunaan penambatan bukan Hilti, keadaan konkrit yang lemah atau meragukan, atau penggunaan unik boleh mempengaruhi kebolehpercayaan atau prestasi pengikatan.

Maklumat Produk

- Sentiasa simpan arahan ini untuk penggunaan bersama dengan produk.
- Pastikan arahan untuk penggunaan berada dengan produk apabila diberi kepada orang lain.
- **Risalah Data Keselamatan:** Tinjau SDS sebelum mengguna.
- **Periksa tarikh tamat tempoh:** Lihat tarikh tamat tempoh tertera di manifold bungkus kerajang (bulan/tahun). Jangan gunakan produk tamat tempoh.
- **Suhu bungkus kerajang semasa penggunaan:** +5 °C hingga 40 °C / 41 °F hingga 104 °F.
- **Syarat untuk pengangkutan dan penyimpanan:** Simpan di tempat dingin, kering dan gelap antara +5 °C hingga 25 °C / 41 °F hingga 77 °F.
- Untuk apa-apa aplikasi tidak dirangkumi oleh dokumentasi ini/melampaui nilai dinyatakan, sila hubungi Hilti.
- **Bungkus kerajang yang digunakan separuh mesti habis digunakan dalam tempoh 4 minggu.** Biarkan pengadun dipasang pada manifold bungkus kerajang dalam pendispens dan jangan retrak ombloh! Tanggalkan hos tekanan udara dan simpan di dalam keadaan simpanan dicadangkan. Jika digunakan semula, pasang dengan pengadun baru dan buang kuantiti permulaan perekat sauh.

AMARAN



⚠ Pengendalian tidak betul boleh menyebabkan mortar terpercik. Sentuhan mata dengan mortar boleh menyebabkan kerosakan mata tidak dapat dipulihkan seperti sedia kala!

- Sentiasa pakai kaca mata keselamatan yang kedap, sarung tangan dan pakaian perlindungan sebelum mengendalikan mortar!
- Jangan sekali-kali mulakan mendispens tanpa pengadun diskrukan dengan betul.
- Apabila menggunakan hos tambahan: Pembuangan aliran mortar awal mestilah dilakukan melalui pengadun yang dibekal sahaja (bukan melalui hos sambungan).
- Pasang pengadun baru untuk mendispens bungkus kerajang baru (pemasangan ketat)
- Amaran! Jangan sekali-kali alihkan pengadun semasa sistem bungkus kerajang berada di bawah tekanan.
- Hanya gunakan jenis pengadun yang dibekalkan dengan perekat. Jangan mengubahsui pengadun dengan apa-apa cara.
- Perikse bungkus kerajang dan pemegang bungkus kerajang untuk kefungsiannya sesuai atau kerosakan – terutamanya selepas ia telah jatuh. Menjatuhkan bungkus kerajang, juga bungkus kerajang yang sudah dimasukkan ke dalam pemegang bungkus kerajang, berkemungkinan menyebabkan kerosakan yang mengakibatkan pincang tugas.
- Jangan sekali-kali gunakan bungkus kerajang rosak dan/atau pemegang bungkus kerajang rosak atau tidak bersih.

⚠ Nilai beban rendah/potensi kegagalan titik pengikatan disebabkan pembersihan lubang jara tidak mencukupi. Lubang jara mestilah bersih daripada serpih-serpihan, habuk, air, ais, minyak, gris dan bahan cemar lain sebelum suntikan perekat.

- Mata gerudi berongga Hilti TE-CD, TE-YD mesti digunakan bersama pembersih vakum Hilti yang diselenggara dengan baik yang mempunyai model dan keupayaan sedutan (kadar aliran isi padu) seperti yang ditetapkan dalam jadual aksesori.
- Untuk menipis keluar daripada lubang jara – tiup keluar dengan udara tanpa minyak sehingga aliran udara kembali adalah bebas daripada habuk yang ketara.
- Untuk mencurahkan air ke lubang jara – curah dengan tekanan talian air sehingga air mengalir dengan lancar.
- Penting! Keluarkan semua air dari lubang jara dan sembur menggunakan udara mangkal bebas minyak sehingga lubang jara benar-benar kering sebelum menyuntik mortar (tidak terpacai untuk lubang yang digerudi penukul dalam kegunaan bawah air).

⚠ Pastikan lubang jara dilisikan dari belakang lubang jara tanpa membentuk lubang udara.

- Jika perlu, gunakan aksesori/sambungan untuk sampai ke belakang lubang jara.
- Untuk aplikasi atas gunakan aksesori atas HIT-SZ/IP dan berhati-hati apabila memasukkan elemen mengikat. Perekat berlebihan mungkin dipaksa keluar dari lubang jara. Pastikan tiada mortar titis ke dalam pemasangan.
- Jika pengadun baru dipasang ke dalam bungkus kerajang yang dibuka sebelum ini, tarikan picu pertama mesti dibuang.

⚠ Tidak mematuhi kepada arahan seting ini boleh mengakibatkan kegagalan titik pengikatan!

ms

Hệ thống neo cấy dùng keo để củng cố cốt thép và neo cấy vào bê tông

- ▶ Trước khi sử dụng, xin vui lòng theo đúng hướng dẫn sử dụng và các biện pháp an toàn bắt buộc về mặt luật pháp.
- ▶ Xem Bảng Dữ liệu An toàn về sản phẩm này.

Hilti HIT-RE 500 V3

Contains: 2,2'-[(1-methylethylidene)bis(4,1-phenyleneoxymethylene)]bisoxirane (A); Trimethylolpropane triglycidylether (A); 2-methyl-1,5-pentanediamine (B); m-Xylylenediamine (B);



Nguy hiểm

- H314 Gây bỏng da nghiêm trọng và nguy hiểm cho mắt.(A,B)
H317 Có thể gây ra phản ứng dị ứng da.(A,B)
H335 Có thể gây kích ứng đường hô hấp (B)
H341 Bị nghi ngờ có thể gây khuyết tật di truyền (A)
H360 Có thể gây hại đến khả năng sinh sản (A)
H319 Gây kích ứng nghiêm trọng cho mắt. (A,B)

- P280 Đeo găng tay bảo vệ/mặc quần áo bảo hộ/dụng cụ bảo vệ mắt/bảo vệ mặt.
P262 Tránh tiếp xúc với mắt, da hoặc quần áo.

P302+P352 TRONG TRƯỜNG HỢP CÓ TIẾP XÚC VỚI DA: rửa lại với thật nhiều nước và xà phòng
P305+P351+P338 NẾU DÍNH MẮT: Rửa thật cẩn thận với nước trong vài phút. Tháo kính áp tròng nếu có và nếu dễ làm. Sau đó tiếp tục rửa

- P333+P313 Nếu da bị dị ứng hoặc phát ban: Hãy xin chỉ dẫn của bác sĩ/thận trọng.
P337+P313 Nếu mắt vẫn bị kích ứng: Hãy xin chỉ dẫn của bác sĩ/thận trọng.

Thiết bị bảo hộ lao động đề nghị:

Bảo vệ mắt: Kính bảo hộ lao động kiểu kín, ví dụ: Kính bảo hộ lao động #02065449 PP EY-CA NCH không màu; Kính bảo hộ lao động #02065591 PP EY-HA R HC/AF không màu;

Găng tay bảo hộ: EN 374; Vật liệu găng tay: Cao su nitril, NBR

Tránh tiếp xúc trực tiếp với hóa chất/ sản phẩm/ việc chuẩn bị các biện pháp tổ chức.

Người sử dụng có trách nhiệm lựa chọn cuối cùng về thiết bị bảo hộ lao động phù hợp

Các cảnh nhắc khi thải bỏ

Gói rỗng

- ▶ Để nguyên vôi trộn và thải bỏ thông qua hệ thống thu gom Green Dot địa phương
 - hoặc mã phế liệu EAK bao bì nhựa 15 01 02



Gói rỗng hoàn toàn hoặc một phần:

- ▶ Phải được hủy bỏ như là một chất thải đặc biệt theo quy định của chính phủ.
 - Mã phế liệu EAK: sơn, mực, keo và nhựa có ký hiệu 20 01 27* chứa các thành phần nguy hiểm.
 - hoặc mã phế liệu: keo và chất trám thái EAK 08 04 09* chứa dung môi hữu cơ và các thành phần nguy hiểm khác.

Hàm lượng: 1400 ml / 47.3 fl.oz

Trọng lượng: 1980 g / 69.8 oz

Bảo hành: Tham khảo các điều khoản và điều kiện Hilti tiêu chuẩn về bán hàng để biết thông tin bảo hành.

Việc không tuân thủ các hướng dẫn lắp đặt này, sử dụng neo không phải của Hilti, tình trạng bề tông kém hoặc có vấn đề hoặc cách sử dụng khác thường có thể ảnh hưởng đến độ tin cậy hoặc hiệu suất của việc định vị.

Thông tin sản phẩm

- Luôn đính kèm hướng dẫn sử dụng này cùng với sản phẩm.
- Đảm bảo rằng hướng dẫn sử dụng luôn đi kèm sản phẩm thậm chí khi đã giao cho người khác.
- **Bảng Dữ liệu An toàn:** Xem lại Bảng Dữ liệu An toàn trước khi sử dụng.
- **Kiểm tra ngày hết hạn:** Hãy xem ngày hết hạn in trên bao bì (tháng/năm). Không dùng sản phẩm hết hạn.
- **Nhiệt độ gói sản phẩm trong quá trình sử dụng:** +5 °C đến 40 °C / 41 °F đến 104 °F.
- **Điều kiện vận chuyển và bảo quản:** Bảo quản ở nơi thoáng mát, khô ráo và tránh ánh sáng trong khoảng nhiệt độ +5 °C đến 25 °C / 41 °F đến 77 °F.
- Đối với những áp dụng không ghi trong tài liệu này/vượt quá giá trị đã định, vui lòng liên hệ với Hilti.
- **Nếu sử dụng gói sản phẩm trong nhiệt độ u là n, phải sử dụng hết trong vòng một tuần n.** Để vôi trộn ke m theo sản phẩm trong thiết bị bơm keo và đư ng rút pit-tông ra! Tháo ống khí nén và bảo quản trong điều kiện bảo quản yêu cầu. Nếu du ng lại, gắn vôi i trộn mới và bổ lượng hóa chất neo cấy ban đầu.

⚠ CẢNH BÁO



⚠ Xử lý không chính xác có thể tạo ra các mảng vữa. Vữa khi tiếp xúc với mắt có thể gây ra những tổn thương không thể hồi phục!

- Luôn mặc quần áo bảo hộ, mang găng tay, kính bảo vệ mắt kín trước khi xử lý vữa!
- Không pha trộn mà không có vôi trộn gắn đúng cách.
- Khi sử dụng ống mềm nối dài: việc loại bỏ dòng vữa ban đầu chỉ được thực hiện thông qua vôi trộn được cung cấp (không thông qua ống mềm nối dài).
- Gắn vôi trộn mới trước khi pha trộn gói sản phẩm mới (đảm bảo vô khuẩn).
- Cảnh báo! Không được tháo vôi trộn khi hệ thống gói đang nén. Chỉ dùng loại vôi trộn được cung cấp kèm theo hóa chất này. Không điều chỉnh vôi trộn dưới bất cứ hình thức nào.
- Kiểm tra gói sản phẩm hoặc giá đỡ để xem khả năng sử dụng hoặc hư hỏng – đặc biệt là sau khi bị rơi. Các gói bị rơi, kể cả gói đã được đưa vào giá đỡ, có thể gây ra hư hỏng hoặc chức năng sẽ kém đi.
- Không sử dụng gói đã hỏng và/hoặc đầu giữ gói bị hỏng hoặc dẹt.

⚠ Giá trị tải trọng kém/không thể định vị các điểm do việc chưa làm sạch lỗ khoan. Lỗ khoan phải khô và không có mảnh vụn, bụi, nước, nước đá, dầu, mỡ và các tạp chất khác bám vào trước khi bơm hóa chất.

- Phải sử dụng mũi khoan lỗ rỗng Hilti TE-CD, TE-YD kết hợp với máy hút bụi Hilti được bảo trì đúng cách có môđen và công suất hút (định mức lưu lượng thể tích) như được quy định trong bảng phụ kiện.
- Để thổi sạch lỗ khoan – hãy thổi bằng khí không dầu cho đến khi luồng khí hồi không có bụi.
- Để phun nước rửa lỗ khoan – hãy phun bằng vòi áp lực đến khi thấy nước ra sạch.
- Lưu ý! Lấy hết nước trên lỗ khoan và thổi bằng khí nén không dầu cho đến khi lỗ khoan hoàn toàn khô trước khi bơm vữa (không dùng cho lỗ khoan bằng búa trong ứng dụng dưới nước).

⚠ Bảo đảm rằng vữa được bơm vào lỗ khoan từ chỗ trong cùng mà không tạo ra các bọt khí.

- Nếu cần thiết, sử dụng thiết bị phụ tùng/phụ kiện để tiếp cận chỗ trong cùng của lỗ khoan.
- Đối với các ứng dụng trên cao, hãy sử dụng phụ kiện trên cao HIT-SZ / IP và cần đặc biệt chú ý khi đưa vào thành phần định vị. Keo thừa có thể bị đẩy ra khỏi lỗ khoan. Phải đảm bảo không có mảng vữa rơi trên dụng cụ lắp đặt.
- Nếu gắn vôi trộn mới vào gói đã mở trước đó, cần phải bỏ đi lớp trên cùng của gói.

⚠ Không tuân theo các hướng dẫn lắp đặt này có thể dẫn đến việc không thể định vị các điểm!

vi

Hiti HIT-RE 500 V3 1400 Jumbo

ระบบพุกเคมีสำหรับตัดยึดเหล็กเส้นและสลักในคอนกรีต

- ▶ ก่อนใช้งานผลิตภัณฑ์นี้ โปรดปฏิบัติตามคำแนะนำการใช้งานและคำเตือนด้านความปลอดภัยตามที่กำหนดโดยกฎหมาย
- ▶ ดูเอกสารข้อมูลด้านความปลอดภัยเกี่ยวกับผลิตภัณฑ์นี้

Hiti HIT-RE 500 V3

มีส่วนประกอบของ: ฆิส [4-(2,3-อีพอกซีโพรพอกซี) ฟีนิล] โพรเพน (A); Trimethylolpropane triglycidylether (A); 2-methyl-1,5-pentanediamine (B); m-Xylylenediamine (B);



(A,B)



(A,B)



(A)



(A)



อันตราย

- H314 เป็นสาเหตุให้ผิวหนังไหม้อย่างสาหัสและทำอันตรายต่อดวงตา (A,B)
- H317 อาจเป็นสาเหตุให้ผิวหนังแสดงอาการแพ้ (A,B)
- H335 อาจระคายเคืองต่อทางเดินหายใจ (B)
- H341 มีข้อสงสัยว่าอาจเกิดความผิดปกติต่อพันธุกรรม (A)
- H360 อาจเกิดอันตรายต่อการเจริญพันธุ์หรือทารกในครรภ์ (A)
- H411 มีพิษต่อสิ่งมีชีวิตในน้ำพร้อมผลกระทบต่อระยะยาว (A,B)

P280 สวมถุงมือป้องกัน/เสื้อผ้ามุ่งกัน/ที่ป้องกันตา/ที่ป้องกันหน้า

P262 ห้ามให้เข้าตา สัมผัสผิวหนัง หรือเยื่อเมือก

P302+P352 ถ้าสัมผัสผิวหนัง ล้างเบาๆ ด้วยสบู่และน้ำจำนวนมาก ๆ

P305+P351+P338 หากเข้าตา: ชะด้วยน้ำอย่างระมัดระวังเป็นเวลาหลายๆนาทีที่ถอดคอนแทกซ์เลนส์ถ้ายังอยู่ที่เดิม และสะดวกที่จะทำก็ให้ชะล้างต่อไป

P333+P313 หากเกิดการระคายเคืองที่ผิวหนังหรือเป็นผื่นคัน: ให้ขอคำปรึกษา/ การรักษาพยาบาลจากแพทย์

P337+P313 หากการระคายเคืองที่ตายังไม่หาย: ให้ขอคำปรึกษา/ การรักษาพยาบาลจากแพทย์

อุปกรณ์ป้องกันที่แนะนำให้ใช้:

การป้องกันตา: แว่นตาที่ขอบปิดสนิท เช่น #02065449 แว่นตานิรภัย PP EY-CA NCH แบบโปร่งใส และ #02065591 แว่นครอบตา PP EY-HA R HC/AF แบบโปร่งใส;

ถุงมือป้องกัน: EN 374; วัสดุที่ใช้ผลิตถุงมือ: ยางไนไตรล์ (NBR)

หลีกเลี่ยงการสัมผัสโดยตรงกับสารเคมี/ ผลิตภัณฑ์/ การผลิตโดยทำตามมาตรการขององค์การผู้ใช้ควรใช้วิจารณญาณในการเลือกใช้อุปกรณ์ป้องกันที่เหมาะสม

การกำจัดทิ้ง

หลุดผลิตภัณฑ์เปล่า:

- ▶ ไม่ต้องถอดหัวผสมออกและให้กำจัดทิ้งผ่านทางระบบจัดเก็บขยะที่มีสัญลักษณ์ Green Dot หรือตามข้อกำหนดสำหรับรหัสของเสีย EAK 15 01 02 บรรจุภัณฑ์พลาสติก



หลุดผลิตภัณฑ์ที่ยังไม่ได้ใช้หรือใช้ไปบางส่วน:

- ▶ กำจัดทิ้งโดยใช้วิธีการสำหรับขยะพิเศษตามกฎหมายข้อบังคับของราชการ
 - รหัสของเสีย EAK 20 01 27* สี หมึก สารยึดติด และเรซินที่มีส่วนผสมของสารอันตราย
 - รหัสหรือรหัสของเสีย EAK 08 04 09* สารยึดติดและสารสำหรับซีลที่มีส่วนผสมของสารทำลายอินทรีย์หรือสารอันตรายอื่นๆ

ปริมาณ: 1400 ml / 47.3 fl.oz

น้ำหนัก: 1980 g / 69.8 oz

การรับประกัน: กรุณาดูข้อกำหนดและเงื่อนไขมาตรฐานของ Hilti เกี่ยวกับการขายในส่วนของคุณสมบัติการรับประกัน

การไม่ปฏิบัติตามคำแนะนำในการติดตั้ง การใช้ที่ไม่ใช่ของ Hilti สภาพของคอนกรีตที่ไม่ดีหรืออาจเป็นปัญหา หรือการใช้งานในลักษณะที่ไม่เหมาะสม อาจส่งผลต่อความมั่นคงและความมีประสิทธิภาพในการยึดเกาะได้

ข้อมูลผลิตภัณฑ์

- โปรดเก็บเอกสารคำแนะนำการใช้งานไว้คู่กับผลิตภัณฑ์เสมอ
- ถ้ามีการส่งต่อผลิตภัณฑ์นี้ให้กับบุคคลอื่นๆ จะต้องมอบเอกสารคำแนะนำการใช้งานนี้ให้แก่บุคคลดังกล่าวด้วย
- เอกสารข้อมูลด้านความปลอดภัย: กรุณาอ่านเอกสารข้อมูลด้านความปลอดภัยก่อนการปฏิบัติงาน
- ตรวจสอบวันหมดอายุ: สังเกตวันหมดอายุที่พิมพ์อยู่บนหลอดพอยส์ที่บริเวณติดตั้งหัวผสม (เดือน/ปี) ห้ามใช้งานผลิตภัณฑ์หมดอายุแล้ว
- อุณหภูมิของหลอดพอยส์ในระหว่างการใช้งาน: +5 °C ถึง 40 °C / 41 °F ถึง 104 °F
- ข้อกำหนดในการขนส่งและจัดเก็บ: เก็บไว้ในที่แห้งและเย็น ไม่ถูกแสง และมีอุณหภูมิระหว่าง +5 °C ถึง 25 °C / 41 °F ถึง 77 °F
- สำหรับการใช้งานที่ไม่มีอ็อกซิเจนไว้ใช้ค่าอนุของหัวที่ระบุในเอกสารนี้ กรุณาติดต่อขอรับข้อมูลจาก Hilti
- หลังจากเปิดหลอดพอยส์แล้ว จะต้องใช้ผลิตภัณฑ์ทั้งหมดภายในหนึ่งถึงสี่ปาดู ไม่ควรเปิดหัวผสมออกจากหลอดพอยส์ในบีนจิด และห้ามถอดกานด้นกลับออกมา! ถอดท่อแรงดันอากาศออก จากนั้นนำจิดกับผลิตภัณฑ์ตามข้อกำหนดที่แนะนำนี้ เมื่อนำหลอดพอยส์ มาใช้งานอีกครั้ง ให้ติดตั้งหัวผสมใหม่และจิดทุกเคมีส่วนแรกทิ้ง

คำเตือน



- ▲การใช้งานผิดวิธีอาจทำให้ทุกเคมีกระเด็นออกมาได้**
หากทุกเคมีสัมผัสโดนดวงตาอาจทำให้เกิดอันตรายต่อดวงตาที่ไม่สามารถรักษาได้!
 - สวมแว่นตาป้องกันที่มีการป้องกันแนวนหนา ถุงมือ และชุดป้องกันทุกครั้งก่อนใช้งานทุกเคมี!
 - ห้ามจิดทุกเคมีหากยังไม่ได้ติดตั้งหัวผสมอย่างถูกต้อง
 - เมื่อใช้ท่อต่อเพิ่มความยาว: การขยับทุกเคมีออกในขั้นตอนจะต้องดำเนินการผ่านทางหัวผสมที่จิดเตรียมไว้ให้เท่านั้น (ไม่ใช่ผ่านท่อต่อเพิ่มความยาว)
 - ติดตั้งหัวผสมใหม่ก่อนที่จะจิดทุกเคมีจากหลอดพอยส์ใหม่ (ขนาดติดตั้งพอดี)
 - ข้อควรระวัง! ห้ามนำหัวผสมออกในขณะที่ระบบของหลอดพอยส์ยังมีแรงดันอยู่
 - ใช้เฉพาะหัวผสมที่ให้มาพร้อมกับทุกเคมีเท่านั้น ห้ามดัดแปลงหัวผสมโดยเด็ดขาด
 - ข้อควรระวัง! ห้ามนำหัวผสมออก ในขณะที่ระบบของหลอดพอยส์ยังมีแรงดันอยู่ ให้กดปุ่มปลดของบีนจิดเพื่อป้องกันไม่ให้ทุกเคมีกระเด็น
 - ห้ามใช้หลอดพอยส์ที่ชำรุด และ/หรือกระบอกครอบที่ชำรุดหรือไม่สะอาด
- ▲ผลิตภัณฑ์คุณสมบัติการรับน้ำหนักด้อยลงหรือไม่สามารถรับน้ำหนักได้ หากไม่ได้ทำตามระบอบการเจาะอย่างเพียงพอเจาะจะ**
ติดตั้งห่าง ปราคจากเศษผง ผุ่น น้ำ น้าแข็ง น้ามัน จาระบี และสิ่งสกปรกอื่นๆ ก่อนที่จะทำการจิดทุกเคมี
 - Hilti ดอกเจาะกลวง TE-CD, TE-YD ต้องใช้ร่วมกับเครื่องดูดฝุ่น Hilti ที่ได้รับการรับรองรักษาอย่างถูกต้องพร้อมด้วยรูปแบบและความสามารถในการดูด (อัตราการไหลปริมาตร) ตามที่ระบุไว้ในตารางเสริม
 - สำหรับการเป่าลมไล่เศษในรูเจาะ ให้เป่าลมที่ปราศจากสะเก็ดของน้ามันเข้าไปในรูเจาะจนกระทั่งลมที่ออกมาจากรูเจาะไม่มีเศษฝุ่นเหลืออยู่
 - สำหรับการจิดน้าไหลเศษในรูเจาะ ให้จิดน้าด้วยแรงดันปกติจากท่อจนกระทั่งน้าที่ไหลอยู่นอกจากรูเจาะไม่มีเศษฝุ่นเหลืออยู่
 - สำคัญ! ให้ขจัดน้าทั้งหมดออกจากรูเจาะ และเป่าด้วยลมอัดที่ปราศจากโอแน่มันจนกระทั่งรูเจาะแห้งสนิท ก่อนจิดทุกเคมี (ไม่สามารถใช้ได้กับรูที่เจาะด้วยสว่านกระแทกในการใช้งานได้น้า)
- ▲ตรวจสอบให้แน่ใจว่าได้จิดทุกเคมีโดยเริ่มจากด้านในสุดของรูเจาะและไม่เกิดฟองอากาศ**
 - ถ้าจำเป็น ให้ใช้อุปกรณ์เสริมรวมทั้งหัวต่อเพิ่มความยาว เพื่อให้สามารถจิดทุกเคมีได้ถึงด้านในสุดของรูเจาะ
 - สำหรับการท้งานเหนือศีรษะ ให้ใช้อุปกรณ์เสริมสำหรับการท้งานเหนือศีรษะ HIT-SZ / IP และใช้ความระมัดระวังขณะติดตั้งผลิตภัณฑ์ ทุกเคมีบางส่วนอาจถูกดันออกจากรูเจาะได้ ระวังอย่าให้ทุกเคมีหยดใส่มีปฏิบิตงาน
 - ในกรณีที่ใช้หัวผสมใหม่กับหลอดพอยส์ที่เคยเปิดใช้มาก่อนแล้ว จะต้องจิดทุกเคมีส่วนแรกทิ้ง
- ▲การไม่ปฏิบัติตามคำแนะนำการติดตั้งข้างต้น อาจส่งผลให้จิดยติมีคุณสมบัติการรับน้ำหนักด้อยลงหรือไม่สามารถรับน้ำหนักได้!**

th

- AE** Hilti Emirates L.L.C.
Dubai Investment Park
AE-Dubai
Tel +971 800 44584
- AR** Hilti Argentina S.R.L.
Professor Manuel Garcia 4760,
B1605 B/B - Munro, AR-Buenos Aires
Tel +54 11 4721 4400
- AT** Hilti Austria Ges.m.b.H.
Altmannsdorferstr. 165
Postfach 316, AT-1231 Wien, Tel +43 1 66101
- AU** Hilti (Aust.) Pty. Ltd.
Level 5, 1G Homebush Bay Drive
Rhodes N.S.W. 2138
Tel +61 131 292
- BE** Hilti Belgium N.V./S.A.
Z.4 Broekvlei 220 , 1731 Asse
Tel +32 2 467 7911
- BR** Hilti do Brasil Comercial Ltda.
Al. Rio Negro, 500 -Torre A
9º andar, 06454-000 Barueri, SP
Tel +55 11 4134 9000
- CH** Hilti (Schweiz) AG, Soodstrasse 61
CH-8134 Adliswil
Tel +41 844 84 84 85
- CL** Hilti Chile Ltda.,
Av. Apoquindo 4501, piso 13,
Las Condes 7550000, Santiago,
Tel +562 655 3000
- CN** 喜利得 (中国) 商贸有限公司
上海市浦东新区耀元路58号环球
都会广场2号楼8层
电话: +86 21 6016 7316 传真: /
邮编: 200126
中国境内化学事故应急咨询电话:
+86-400-6267-911
- CR** Superba S.A., 200 Mts. Oeste de Matra
la Uruca, CR-San Jose,
Tel +506 2255 1044
- CY** Cyprus Trading Corp. Ltd.
Domex Operations, CTC House,
Athlassa
P.O. Box 21744, CY-1589 Nicosia
Tel +357 22 740 340
- DE** Hilti Deutschland AG
Hiltistr. 2, D-86916 Kaufering
Tel +49 8191 90-0
- ES** HILTI ESPAÑOLA, S.A.
Camino Fuente de la Mora, 1-3a planta
ES-28050 Madrid, Tel +34 902 10 04 75
- FR** Hilti France S.A.S.
126 rue Gallieni
92100 Boulogne-Billancourt
Tel +33 825 01 05 05
- GB** Hilti (Gt. Britain) Ltd.
1 Trafford Wharf Road
Trafford Park, GB-M17 1BY Manchester
Tel +44 161 886 1000
- GR** HILTI Ελλάς AEE Α.
Κύμης 132 15123 Μαρούσι,
Αθήνα - Ελλάδα
T +30 210 288 0600
- HK** Hilti (Hong Kong) Ltd.
701-704, 7/F, Tower A
Manulife Financial Centre
223 Wai Yip Street, Kwun Tong
KowloonTel +852 27734 700
- ID** P.T. Hilti Nusantara
The Garden Center Level 3 No. 3-11B
Kawasan Komersial Cilandak
Jl. Raya Cilandak KKO, 12560 Jakarta
Tel +62 21 789 0850
- IE** Hilti (Fastening Systems) Limited
Unit C4 , North City Business Park
Finglas , IRL-Dublin 11
Tel +353 188 64101
- IN** Hilti India Private Limited
F-90/4, Okhla Industrial Area Phase 1
New Delhi 110 020
Tel +9111 4270 1111
- IT** Hilti Italia S.p.A.
Piazza Montanelli 20
IT-20099 Sesto San Giovanni (Milano)
Tel +39 02 212 72
- JP** 日本ヒルティ株式会社
神奈川県横浜市都筑区茅ヶ
崎南2-6-20
224-8550 〒 - 日本
T +81 45 943 6211
- KR** 힐티코리아(주)
서울시 송파구 법원로11길 12
(문정동, 한양타워 7층)
05836 서울 - Korea
T 080-220-2000 (수신자 부담)
- LI** Hilti AG
Feldkircherstraße 100
9494 Schaan
Tel +423 234 2111
- MA** Hilti Maroc
6, Allée des Cyprés, Ain Sebâa
MA-Casablanca
Tel +212 522 67 58 00
- MX** Hilti Mexicana, S.A. de C.V.
Jaime Balmes 8, Oficina 102, 1er Piso
Col. Los Morales Polanco
Del. Miguel Hidalgo
MEX-Mexico City 11510
Tel +5255 5387-1600
- MY** Hilti (Malaysia) Sdn. Bhd.
F-5-A, Sime Darby Brunsfield Tower,
No. 2, Jalan PJU 1A/7A
Oasis Square, Oasis Damansara
MY-47301 Petaling Jaya
Tel +60 3 5628 7222
- NL** Hilti Nederland B.V.
Leeuwenhoekstraat 4
NL-2652 XL Berkel en Rodenrijs
Tel +31 10 5191111
- NZ** Hilti (New Zealand) Ltd.
Level 1, Building B 600 South Road
Eilerslie 1051
NZ-Auckland
Tel +64 9 571 9995
- PH** Hilti (Philippines) Inc.
2256 Pasong Tamo Extension
Edsa, Bryg. Magallanes
1224, Makati City
Tel +632 784 7100
- PT** Hilti (Portugal)
Produtos e Serviços lda,
Rua da Lionesa, nº 446, Ed. C39
PT-4465-671 Leça do Balio
Tel +351 808 200 111
- QA** Hilti Qatar W.L.L.
Souq Al Rawda, Salwa Road
24097 Doha Ad Dawhah
Tel +974 4406 3600
- SA** Hilti Saudi Arabia for Construction Tools
LLC, Kilo 14, King Fahd Street
P.O Box 15930, KSA-21454 Jeddah
Tel +966 2 213 8400
- SG** Hilti Far East Private Ltd.
No 20 Harbour Drive,
#06-06/08 PSA Vista
SGP-Singapore 117612
Tel +65 6777 7887
- TH** บริษัท ฮิลติ (ไทยแลนด์) จำกัด
1858/107-108 อาคาร
อินเตอร์ลิงค์ ชั้น 24
10260 กรุงเทพมหานคร - Thailand
T +66 2 714 5300
- TR** Hilti İnşaat Malz. Tic. A.Ş.
Barbaros Mahallesi
Ağaoğlu My Office Çiğdem Sok.
No:15/A, 34746 Ataşehir/İstanbul
Tel +90 216 528 68 00
- TW** 喜利得股份有限公司
新北市板橋區新站路16號24樓
220 台北 - 臺灣
T +886 2 6630 0345
- ZA** Hilti (South Africa) (Pty) Ltd.
2 Tugela Lane
Waterfall Logistics Precinct
Corner Bridal Veil Road and R101
2090 Midrand
Tel +2711 2373000



19

Hilti AG
FL-9494 Schaan
Hilti Werke

1343-CPR-M 500-23/07.14
ETA-16/0143
Notified body 1343
EAD 330499-01
Seismic C1, (C2)
www.hilti.group



19

Hilti AG
FL-9494 Schaan
Hilti Werke

1343-CPR-M 500-22/07.14
ETA-16/0142
Notified body 1343
EAD 331522-00
www.hilti.group



16

Hilti AG
FL-9494 Schaan
Hilti Werke

1343-CPR-M 500-24/07.14
ETA-16/0180
Notified body 1343
ETAG 001-1, -5 Option 1
Seismic C1
www.hilti.group



18

Hilti AG
FL-9494 Schaan
Hilti Werke

1343-CPR-M 500-40/07.14
ETA-18/0745
Notified body 1343
EAD 332077-00
(Seismic C1, C2)
www.hilti.group



19

Hilti AG
FL-9494 Schaan
Hilti Werke

1343-CPR-M 500-41/07.14
ETA-18/1022
Notified body 1343
EAD 332347-00
www.hilti.group



19

Hilti AG
FL-9494 Schaan
Hilti Werke

1343-CPR-M 500-48/07.14
ETA-19/0194
Notified body 1343
EAD 130006-00
www.hilti.group

Info | Shop



[http://qr.hilti.com/
r4929903](http://qr.hilti.com/r4929903)



414647

www.hilti.group

Hilti = registered trademark of Hilti Corporation, Schaan, Liechtenstein

© 2020

Right of technical changes reserved S.E. & O.

Made in Germany

414647 V06 07.2020